

MAPH Series Fluid+Electric Slip rings

Pneumatic/Hydraulic+Electric slip ring is rotating device that can transmit electric and gas or oil when free 360° rotating, mainly used for rotating index with cylinder and servo motor.



Features

- Transmitting gas, liquid, power and signal etc. when 360° rotating
- Support 1/2/3/4/5/6/8/10/12/16 Pneumatic/Hydraulic passages.
- Can combine 1~128 wires electrical power/signal.
- Connection size :M5", G1/8", G1/4", G3/8", G1/2", G3/4", G1"
- Pipe size for liquid&gas can be specified.
- Media type: air/gas, chemical, DI/Tap water, oil .
- High speed and high voltage can be customized .

MAPH Series Models

Model#	Pneumatic/Hydraulic Passages	Mixed Circuits	Connection size	Pipe size	Remarks
MAPH100	1 passage	1~96	M5 ; G1/8 ; G1/4 ; G3/8 ; G1/2	3mm~20mm	*
MAPH101	1 passage	1~96	G1/8 ; G3/8	3mm~20mm	*
MAPH104	1 inlet, 4 outlets	1~96	M5 ; G1/8 ; G1/4 ; G3/8 ; G1/2	3mm~20mm	*
MAPH200	2 passages	1~96	M5 ; G1/8 ; G1/4 ; G3/8 ; G1/2	3mm~20mm	*
MAPH200S	2 passages	1~56	M5 ; G1/8 ; G1/4 ; G3/8 ; G1/2	3mm~20mm	flange side exit
MAPH200F	2 passages	1~96	M5 ; G1/8 ; G1/4 ; G3/8 ; G1/2	3mm~20mm	double flange, 100KG load
MAPH200W	2 passages	1~96	M5 ; G1/8 ; G1/4 ; G3/8 ; G1/2	3mm~20mm	*
MAPH300	3 passages	1~96	M5 ; G1/8 ; G1/4 ; G3/8 ; G1/2	3mm~20mm	*
MAPH300S	3 passages	1~56	M5 ; G1/8 ; G1/4 ; G3/8 ; G1/2	3mm~20mm	flange side exit
MAPH300F	3 passages	1~96	M5 ; G1/8 ; G1/4 ; G3/8 ; G1/2	3mm~20mm	*
MAPH400	4 passages	1~96	M5 ; G1/8 ; G1/4 ; G3/8 ; G1/2	3mm~20mm	*
MAPH400S	4 passages	1~56	M5 ; G1/8 ; G1/4 ; G3/8 ; G1/2	3mm~20mm	flange side exit
MAPH400F	4 passages	1~96	M5 ; G1/8 ; G1/4 ; G3/8 ; G1/2	3mm~20mm	double flange, 100KG load
MAPH400W	4 passages	1~96	M5 ; G1/8 ; G1/4 ; G3/8 ; G1/2	3mm~20mm	*
MAPH600	6 passages	1~96	M5 ; G1/8 ; G1/4 ;	3mm~12mm	*
MAPH600S	6 passages	1~56	M5 ; G1/8 ; G1/4 ; G3/8 ; G1/2	3mm~20mm	flange side exit
MAPH600F	6 passages	1~96	M5 ; G1/8 ; G1/4 ;	3mm~12mm	*
MAPH800	8 passages	1~96	M5 ; G1/8 ; G1/4 ;	3mm~12mm	*
MAPH1000	10 passages	1~96	M5 ;	3mm~8mm	*
MAPH1200	12 passages	1~96	M5 ;	3mm~8mm	*
MAPH1600	16 passages	1~96	M5 ;	3mm~8mm	*

60% of MOFLON's sales are customized solutions, If you need to be customized, please contact: technical@moflon.com

MAPH100

1 Passage Fluid + Electrical Slip Ring



MAPH100 is 1 passage Pneumatic /Hydraulic + 2~96rings Electrical Slip Ring.
 Connection size including: M5,G1/8", G1/4", G3/8",G1/2" and bigger on request.
 Electrical rings including power wire, signal wire,Ethernet, USB, Industrial BUS, control Net, and all kinds of sensitive signal, etc. Normally use flange for installation, hollow shaft intallation on request.
 Media Types: Air/Gas,hydrogen,Nitrogen,Chemical, Water,Oil,etc.

Part# Explanation

MAPH100-01-G0601 - P 06 10- S 06 - VC

MAPH: Pneumatic/Hydraulic +Electrical Slip ring

100 : 1 Inlet 1 outlet Pneumatic/Hydraulic

01: M5 port , 02: G1/8 port, 03: G1/4 port
 04: G3/8 port, 05: G1/2 port

G04: 4mm tube; G06: 6mm tube; G08: 8mm tube
 G10: 10mm tube; G12: 12mm tube

01: straight joint for both rotor and stator;
 02: straight joint for rotor , 90° bend for stator;
 03: straight joint for stator , 90° bend for rotor;
 04: 90° bend joint for rotor and stator

Product quality level
 VC-common quality version
 VD-industrial quality version
 Default=VC
 06: signal ring (0-5A/ring)
 S: signal ring
 0610: 6 rings , 0-10A/ring
 P: power ring

1 passage , M5 MAPH100-01 Dimensions

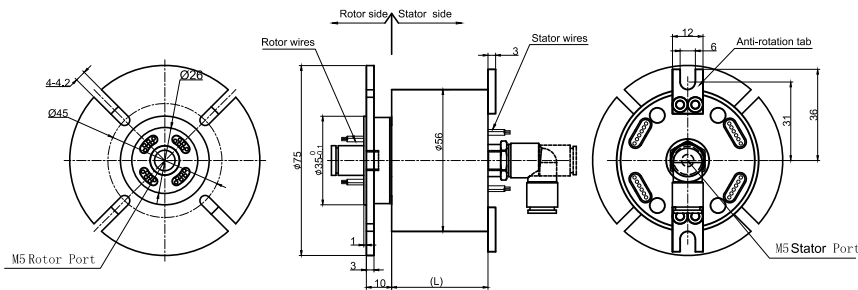

1 passage , G1/8 MAPH100-02 Dimensions

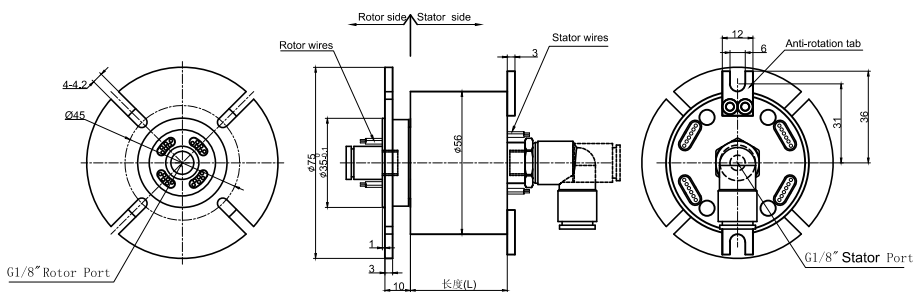

1 passage , G1/4 MAPH100-03 Dimensions

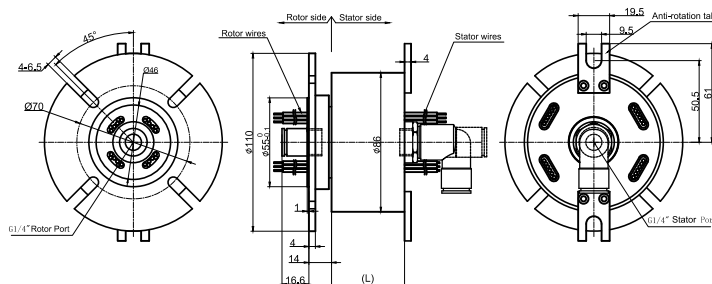

1 passage , G3/8 MAPH100-04 Dimensions

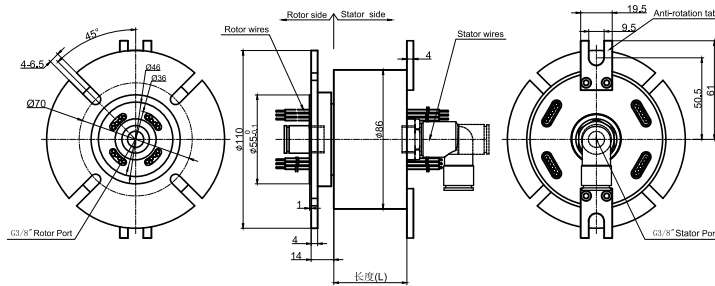

1 passage , G1/2 MAPH100-05 Dimensions

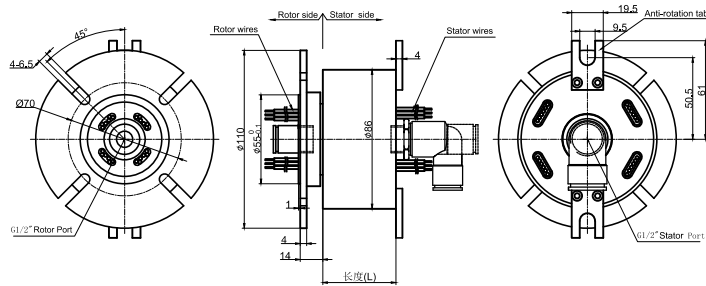

Specifications

Rotary Union Specifications			Mechanical Data	
Parameter	Value		Parameter	Value
Passage	1 passage		Working Life	See Product Quality Level Table
Max Pressure	10MPa; Vacuum 0.01torr		Rotating Speed	See Product Quality Level Table
Torque	depend on connection size		Working Temperature	-30°C~80°C
Electrical Data			Operating Humidity	0~85% RH
Parameter	Value		Contact Material	Precious Metal
	Power	Signal	Housing Material	Aluminium Alloy
Rated Voltage	0~440VAC/VDC	0~440VAC/VDC	Protection Grade	IP51
Insulation Resistance	≥1000MΩ/500VDC			
Lead Wires	AWG16#Teflon (MAPH00-03/04)			
	AWG17#Teflon (MAPH00-01/02)			
Lead Length	standard 300mm(adjustable)			
Insulation Strength	500VAC@50Hz,60s			
Electrical Noise	<0.01Ω			

Part# List

MAPH100-01, MAPH100-02 Pneumatic/Hydraulic Slip Ring
 1) XX=01, Connection size=M5
 2) XX=02, Connection size=G1/8

Part#	Pneumatic/Hydraulic Passage	10A	Signal 5A	Length(mm)	Part#	Pneumatic/Hydraulic Passage	10A	Signal 5A	Length(mm)
MAPH100-XX-S06	1 Passage	0	6	38	MAPH100-XX-P0810-S10	1 Passage	8	10	71.6
MAPH100-XX-P0210-S04	1 Passage	2	4	38	MAPH100-XX-P1010-S08	1 Passage	10	8	71.6
MAPH100-XX-P0410-S02	1 Passage	4	2	38	MAPH100-XX-P1210-S06	1 Passage	12	6	71.6
MAPH100-XX-P0610	1 Passage	6	0	38	MAPH100-XX-P1410-S04	1 Passage	14	4	71.6
MAPH100-XX-S12	1 Passage	12	0	54.8	MAPH100-XX-P1610-S02	1 Passage	16	2	71.6
MAPH100-XX-P0210-S10	1 Passage	2	10	54.8	MAPH100-XX-S24	1 Passage	0	24	88.4
MAPH100-XX-P0310-S09	1 Passage	3	9	54.8	MAPH100-XX-P0410-S20	1 Passage	4	20	88.4
MAPH100-XX-P0610-S06	1 Passage	6	6	54.8	MAPH100-XX-P0610-S18	1 Passage	6	18	88.4
MAPH100-XX-P0810-S04	1 Passage	8	4	54.8	MAPH100-XX-P1210-S12	1 Passage	12	12	88.4
MAPH100-XX-P1010-S02	1 Passage	10	2	54.8	MAPH100-XX-S30	1 Passage	0	30	105.2
MAPH100-XX-P1210	1 Passage	12	0	54.8	MAPH100-XX-P0610-S24	1 Passage	6	24	105.2
MAPH100-XX-S18	1 Passage	0	18	71.6	MAPH100-XX-S36	1 Passage	0	36	125
MAPH100-XX-P0210-S16	1 Passage	2	16	71.6	MAPH100-XX-S42	1 Passage	0	42	141.8
MAPH100-XX-P0410-S14	1 Passage	4	14	71.6	MAPH100-XX-S48	1 Passage	0	48	158.6
MAPH100-XX-P0610-S12	1 Passage	6	12	71.6					

Note: N channels 10A rings parallel can be used as 1 channel N*10A current. For example: 2 rings 10A parallel could be used as 1 wires 20A.

10A and Signal(5A) can be combine in any way as you need. Max. ring: 96 rings, can be customized based on standard slip rings. Please contact us.

Part# List

MAPH100-03, MAPH100-04, MAPH100-05Pneumatic/Hydraulic Slip Ring 1) XX=03, Connection size=G1/4" 2) XX=04, Connection size=G3/8" 3) XX=05, Connection size=G1/2"									
Part#	Pneumatic/Hydraulic Passage	10A	Signal or 5A	Length (mm)	Part#	Pneumatic/Hydraulic Passage	10A	Signal or 5A	Length (mm)
MAPH100-XX-S06	1 Passage	0	6	45.2	MAPH100-XX-S36	1 Passage	0	36	150.2
MAPH100-XX-P0210-S04	1 Passage	2	4	45.2	MAPH100-XX-P0610-S30	1 Passage	6	30	150.2
MAPH100-XX-P0410-S02	1 Passage	4	2	45.2	MAPH100-XX-P1210-S24	1 Passage	12	24	150.2
MAPH100-XX-P0610	1 Passage	6	0	45.2	MAPH100-XX-P3610	1 Passage	36	0	150.2
MAPH100-XX-S12	1 Passage	0	12	65.6	MAPH100-XX-S42	1 Passage	0	42	170.6
MAPH100-XX-P0210-S10	1 Passage	2	10	65.6	MAPH100-XX-P0610-S36	1 Passage	6	36	170.6
MAPH100-XX-P0310-S09	1 Passage	3	9	65.6	MAPH100-XX-P1210-S30	1 Passage	12	30	170.6
MAPH100-XX-P0610-S06	1 Passage	6	6	65.6	MAPH100-XX-P4210	1 Passage	42	0	170.6
MAPH100-XX-P0810-S04	1 Passage	8	4	65.6	MAPH100-XX-S48	1 Passage	0	48	193.2
MAPH100-XX-P1010-S02	1 Passage	10	2	65.6	MAPH100-XX-P0610-S42	1 Passage	6	42	193.2
MAPH100-XX-P1210	1 Passage	12	0	65.6	MAPH100-XX-P1210-S36	1 Passage	12	36	193.2
MAPH100-XX-S18	1 Passage	0	18	86	MAPH100-XX-P1810-S30	1 Passage	18	30	193.2
MAPH100-XX-P0210-S16	1 Passage	2	16	86	MAPH100-XX-P2410-S24	1 Passage	24	24	193.2
MAPH100-XX-P0410-S14	1 Passage	4	14	86	MAPH100-XX-P4810	1 Passage	48	0	193.2
MAPH100-XX-P0610-S12	1 Passage	6	12	86	MAPH100-XX-S60	1 Passage	0	60	234
MAPH100-XX-P0810-S10	1 Passage	8	10	86	MAPH100-XX-P0610-S54	1 Passage	6	54	234
MAPH100-XX-P1010-S08	1 Passage	10	8	86	MAPH100-XX-P0910-S51	1 Passage	9	51	234
MAPH100-XX-P1210-S06	1 Passage	12	6	86	MAPH100-XX-P1210-S48	1 Passage	12	48	234
MAPH100-XX-P1410-S04	1 Passage	14	4	86	MAPH100-XX-P2410-S36	1 Passage	24	36	234
MAPH100-XX-P1610-S02	1 Passage	16	2	86	MAPH100-XX-S72	1 Passage	0	72	277.8
MAPH100-XX-S24	1 Passage	0	24	106.4	MAPH100-XX-P1210-S60	1 Passage	12	60	277.8
MAPH100-XX-P0410-S21	1 Passage	4	20	106.4	MAPH100-XX-P2410-S48	1 Passage	24	48	277.8
MAPH100-XX-P0610-S18	1 Passage	6	18	106.4	MAPH100-XX-P3610-S36	1 Passage	36	36	277.8
MAPH100-XX-P1210-S12	1 Passage	12	12	106.4	MAPH100-XX-P1210-S18	1 Passage	12	18	126.8
MAPH100-XX-P1810-S06	1 Passage	18	6	106.4	MAPH100-XX-P1810-S12	1 Passage	18	12	126.8
MAPH100-XX-P2410	1 Passage	24	0	106.4	MAPH100-XX-P2410-S06	1 Passage	24	6	126.8
MAPH100-XX-S30	1 Passage	0	30	126.8	MAPH100-XX-P3010	1 Passage	30	0	126.8
MAPH100-XX-P0610-S24	1 Passage	6	24	126.8					

Note: N channels 10A rings parallel can be used as 1 channel N*10A current. For example: 2 rings 10A parallel could be used as 1 wires 20A.
10A and Signal(5A) can be combine in any way as you need. Max.ring:96 rings.Can be customized based on standard slip rings.Please contact us.

Product Quality Level Table

Products Level Code	Max Rotating Speed	Working Life	Sealing Element
VC	100RPM	10 Million Revs	Common Seals
VD	300RPM	30 Million Revs	High-Quality Seals

Lead Wires Color Code

Ring	1	2	3	4	5	6	7	8	9	10	11	12
Color	BLK	RED	YLW	GRN	BLU	WHT	BLK	RED	YLW	GRN	BLU	WHT

(6 wires for 1 group color, from 7-12, repeat the same color as 1...6, indicated with number code pipe)

Options for custom slip ring

Note: Below special demands can be customized. According, the delivery date will be extended 3 to 15 days; also the cost will be increased 30% to 50%. Most of our basic parts are standard and modular, which can save the cost and lead time.

- ① Cable exit way and cable length can be customized for both rotor and stator.
- ② Because of the structure limitation, length/height/OD can be customized on your request.
- ③ Support current or signal up to 200 rings.
- ④ Aviation plug, terminal and heat-shrink tube are optional.
- ⑤ Hybrid slip ring for Yaskawa/Panasonic/Siemens servo control signal, power line and encoder line.
- ⑥ Support mixed high speed data transmission (including Ethernet, USB, RS232, RS485, Profibus, CanBUS, CANOPEN, DeviceNET, CC-LINK, ProfINET, EtherCAT, etc.)

- ⑦ Can combine temperature control signal with thermocouple signal.
 - ⑧ Special environment can be customized, such as quakeproof, high temperature, etc.
 - ⑨ Hybrid Pneumatic/hydraulic and electric slip ring can be mixed.
 - ⑩ High temperature can up to 500 degrees.
 - ⑪ High voltage can up to 110KV
 - ⑫ Rotating speed can up to 10000RPM
 - ⑬ Maximum current can up to 5000 amperes.
 - ⑭ Military grade
 - ⑮ Optional for underwater IP65, IP68.
 - ⑯ Optional for stainless steel housing
- Technical support :technical@moflon.com

MAPH101

1 Passage Fluid + Electrical Slip Ring



MAPH100 is 1 passage Pneumatic /Hydraulic + 2~96rings Electrical Slip Ring.
 Connection size including: G1/8", G3/8", and bigger on request.
 Electrical rings including power wire, signal wire, Ethernet, USB, Industrial BUS, control Net, and all kinds of sensitive signal, etc. Normally use flange for installation, hollow shaft intallation on request.
 Media Types: Air/Gas,hydrogen,Nitrogen,Chemical, Water,Oil,etc.

Part# Explanation

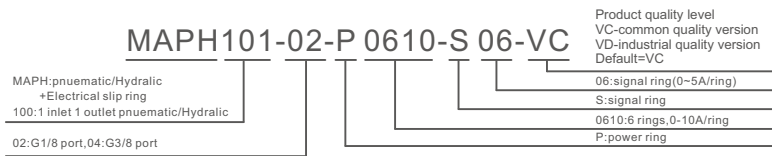

1 passage , G1/8 MAPH100-02 Dimensions

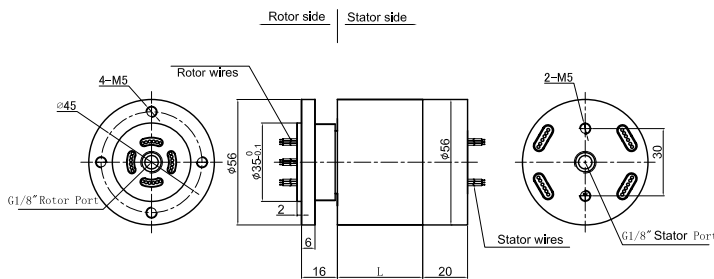

1 passage , G3/8 MAPH100-04 Dimensions

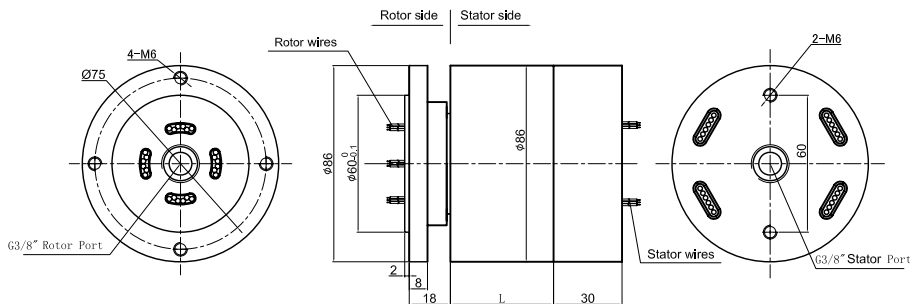

Specifications

Rotary Union Specifications			Mechanical Data	
Parameter	Value		Parameter	Value
Passage	1 passage		Working Life	See Product Quality Level Table
Max Pressure	10MPa; Vacuum 0.01torr		Rotating Speed	See Product Quality Level Table
Torque	depend on conection size		Working Temperature	-30°C~80°C
Electrical Data			Operating Humidity	0~85% RH
Parameter	Value		Contact Material	Precious Metal
	Power	Signal	Housing Material	Aluminium Alloy
Rated Voltage	0~440VAC/VDC	0~440VAC/VDC	Protection Grade	IP51
Insulation Resistance	≥1000MΩ/500VDC			
Lead Wires	AWG17#Teflon	AWG22#Teflon		
Lead Length	standard 300mm(adjustable)			
Insulation Strength	500VAC@50Hz,60s			
Electrical Noise	<0.01μ			

Part# List

MAPH100-02 Pneumatic/Hydraulic Slip Ring 02,Connection size=G1/8									
Part#	Pneumatic/Hydraulic Passage	10A	Signal 5A	Length(mm)	Part#	Pneumatic/Hydraulic Passage	10A	Signal 5A	Length(mm)
MAPH101-02-S06	1 Passage	0	6	38	MAPH100-02-P0810-S10	1 Passage	8	10	71.6
MAPH101-02-P0210-S04	1 Passage	2	4	38	MAPH100-02-P1010-S08	1 Passage	10	8	71.6
MAPH101-02-P0410-S02	1 Passage	4	2	38	MAPH100-02-P1210-S06	1 Passage	12	6	71.6
MAPH101-02-P0610	1 Passage	6	0	38	MAPH100-02-P1410-S04	1 Passage	14	4	71.6
MAPH101-02-S12	1 Passage	12	0	54.8	MAPH100-02-P1610-S02	1 Passage	16	2	71.6
MAPH101-02-P0210-S10	1 Passage	2	10	54.8	MAPH100-02-S24	1 Passage	0	24	88.4
MAPH101-02-P0310-S09	1 Passage	3	9	54.8	MAPH100-02-P0410-S20	1 Passage	4	20	88.4
MAPH101-02-P0610-S06	1 Passage	6	6	54.8	MAPH100-02-P0610-S18	1 Passage	6	18	88.4
MAPH101-02-P0810-S04	1 Passage	8	4	54.8	MAPH100-02-P1210-S12	1 Passage	12	12	88.4
MAPH101-02-P1010-S02	1 Passage	10	2	54.8	MAPH100-02-S30	1 Passage	0	30	105.2
MAPH101-02-P1210	1 Passage	12	0	54.8	MAPH100-02-P0610-S24	1 Passage	6	24	105.2
MAPH101-02-S18	1 Passage	0	18	71.6	MAPH100-02-S36	1 Passage	0	36	125
MAPH101-02-P0210-S16	1 Passage	2	16	71.6	MAPH100-02-S42	1 Passage	0	42	141.8
MAPH101-02-P0410-S14	1 Passage	4	14	71.6	MAPH100-02-S48	1 Passage	0	48	158.6
MAPH101-02-P0610-S12	1 Passage	6	12	71.6					

Note:N channels 10A rings parallel can be used as 1 channel N*10A current. For example: 2 rings 10A parallel could be used as 1 wires 20A.
10A and Signal(5A) can be combine in any way as you need.Max.ring:96 rings,can be customized based on standard slip rings.Please contact us.

Part# List

MAPH100-04 Pneumatic/Hydraulic Slip Ring 04,Connection size=G3/8"									
Part#	Pneumatic/Hydraulic Passage	10A	Signal or 5A	Length (mm)	Part#	Pneumatic/Hydraulic Passage	10A	Signal or 5A	Length (mm)
MAPH101-04-S06	1 Passage	0	6	45.2	MAPH100-04-S36	1 Passage	0	36	150.2
MAPH101-04-P0210-S04	1 Passage	2	4	45.2	MAPH100-04-P0610-S30	1 Passage	6	30	150.2
MAPH101-04-P0410-S02	1 Passage	4	2	45.2	MAPH100-04-P1210-S24	1 Passage	12	24	150.2
MAPH101-04-P0610	1 Passage	6	0	45.2	MAPH100-04-P3610	1 Passage	36	0	150.2
MAPH101-04-S12	1 Passage	0	12	65.6	MAPH100-04-S42	1 Passage	0	42	170.6
MAPH101-04-P0210-S10	1 Passage	2	10	65.6	MAPH100-04-P0610-S36	1 Passage	6	36	170.6
MAPH101-04-P0310-S09	1 Passage	3	9	65.6	MAPH100-04-P1210-S30	1 Passage	12	30	170.6
MAPH101-04-P0610-S06	1 Passage	6	6	65.6	MAPH100-04-P4210	1 Passage	42	0	170.6
MAPH101-04-P0810-S04	1 Passage	8	4	65.6	MAPH100-04-S48	1 Passage	0	48	193.2
MAPH101-04-P1010-S02	1 Passage	10	2	65.6	MAPH100-04-P0610-S42	1 Passage	6	42	193.2
MAPH101-04-P1210	1 Passage	12	0	65.6	MAPH100-04-P1210-S36	1 Passage	12	36	193.2
MAPH101-04-S18	1 Passage	0	18	86	MAPH100-04-P1810-S30	1 Passage	18	30	193.2
MAPH101-04-P0210-S16	1 Passage	2	16	86	MAPH100-04-P2410-S24	1 Passage	24	24	193.2
MAPH101-04-P0410-S14	1 Passage	4	14	86	MAPH100-04-P4810	1 Passage	48	0	193.2
MAPH101-04-P0610-S12	1 Passage	6	12	86	MAPH100-04-S60	1 Passage	0	60	231.8
MAPH101-04-P0810-S10	1 Passage	8	10	86	MAPH100-04-P0610-S54	1 Passage	6	54	234
MAPH101-04-P1010-S08	1 Passage	10	8	86	MAPH100-04-P0910-S51	1 Passage	9	51	234
MAPH101-04-P1210-S06	1 Passage	12	6	86	MAPH100-04-P1210-S48	1 Passage	12	48	234
MAPH101-04-P1410-S04	1 Passage	14	4	86	MAPH100-04-P2410-S36	1 Passage	24	36	234
MAPH101-04-P1610-S02	1 Passage	16	2	86	MAPH100-04-S72	1 Passage	0	72	277.8
MAPH101-04-S24	1 Passage	0	24	106.4	MAPH100-04-P1210-S60	1 Passage	12	60	277.8
MAPH101-04-P0410-S20	1 Passage	4	20	106.4	MAPH100-04-P2410-S48	1 Passage	24	48	277.8
MAPH101-04-P0610-S18	1 Passage	6	18	106.4	MAPH100-04-P3610-S36	1 Passage	36	36	277.8
MAPH101-04-P1210-S12	1 Passage	12	12	106.4	MAPH100-04-P1210-S18	1 Passage	12	18	126.8
MAPH101-04-P1810-S06	1 Passage	18	6	106.4	MAPH100-04-P1810-S12	1 Passage	18	12	126.8
MAPH101-04-P2410	1 Passage	24	0	106.4	MAPH100-04-P2410-S06	1 Passage	24	6	126.8
MAPH101-04-S30	1 Passage	0	30	126.8	MAPH100-04-P3010	1 Passage	30	0	126.8
MAPH101-04-P0610-S24	1 Passage	6	24	126.8					

Note:N channels 10A rings parallel can be used as 1 channel N*10A current. For example: 2 rings 10A parallel could be used as 1 wires 20A.
10A and Signal(5A) can be combine in any way as you need.Max.ring:96 rings.Can be customized based on standard slip rings.Please contact us.

Product Quality Level Table

Products Level Code	Max Rotating Speed	Working Life	Sealing Element
VC	100RPM	10 Million Revs	Common Seals
VD	300RPM	30 Million Revs	High-Quality Seals

Lead Wires Color Code

Ring	1	2	3	4	5	6	7	8	9	10	11	12
Color	BLK	RED	YLW	GRN	BLU	WHT	BLK	RED	YLW	GRN	BLU	WHT

(6 wires for 1 group color, from 7-12, repeat the same color as 1...6, indicated with number code pipe)

Options for custom slip ring

Note: Below special demands can be customized. According, the delivery date will be extended 3 to 15 days; also the cost will be increased 30% to 50%. Most of our basic parts are standard and modular, which can save the cost and lead time.

- ① Cable exit way and cable length can be customized for both rotor and stator.
- ② Because of the structure limitation, length/height/OD can be customized on your request.
- ③ Support current or signal up to 200 rings.
- ④ Aviation plug, terminal and heat-shrink tube are optional.
- ⑤ Hybrid slip ring for Yaskawa/Panasonic/Siemens servo control signal, power line and encoder line.
- ⑥ Support mixed high speed data transmission (including Ethernet, USB, RS232, RS485, Profibus, CanBUS, CANOPEN, DeviceNET, CC-LINK, Profinet, EtherCAT, etc.)
- ⑦ Can combine temperature control signal with thermocouple signal.
- ⑧ Special environment can be customized, such as quakeproof, high temperature, etc.
- ⑨ Hybrid Pneumatic/hydraulic and electric slip ring can be mixed.
- ⑩ High temperature can up to 500 degrees.
- ⑪ High voltage can up to 110KV
- ⑫ Rotating speed can up to 10000RPM
- ⑬ Maximum current can up to 5000 amperes.
- ⑭ Military grade
- ⑮ Optional for underwater IP65, IP68.
- ⑯ Optional for stainless steel housing

Technical support :technical@moflon.com

MAPH104

1 Inlet 4 Outlet Fluid Electrical Slip Ring



MAPH104 is 1 passage Pneumatic /Hydraulic + 2~96rings Electrical Slip Ring.
 Connection size including: M5,G1/8", G1/4", G3/8",G1/2" and bigger on request.
 Electrical rings including power wire, signal wire,Ethernet, USB, Industrial BUS, control Net, and all kinds of sensitive signal, etc. Normally use flange for installation, hollow shaft intallation on request.
 Media Types: Air/Gas,hydrogen,Nitrogen,Chemical, Water,Oil,etc.

Part# Explanation

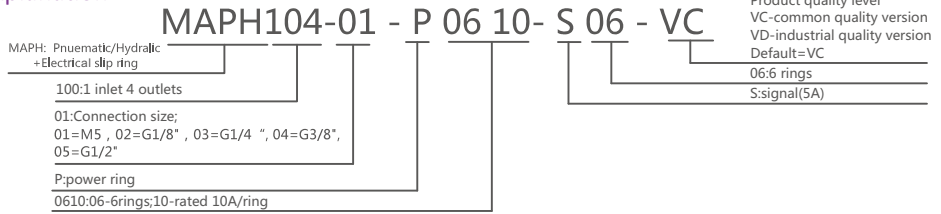

1 inlet 4 outlets , M5 Joint MAPH104-01 Dimensions

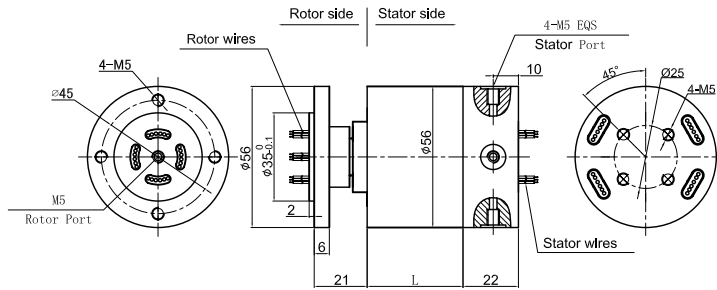

1 inlet 4 outlets , G1/8 Joint MAPH104-02 Dimensions

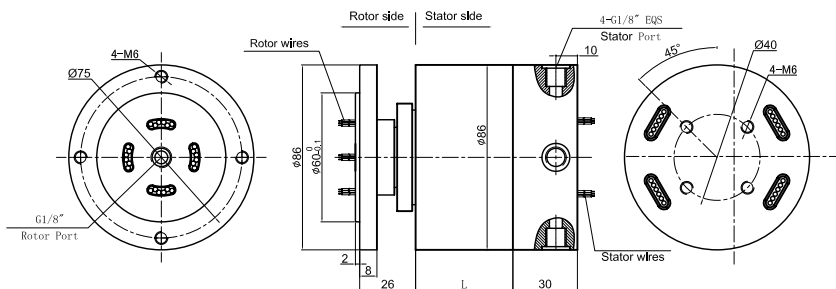

1 inlet 4 outlets , G1/4 Joint MAPH104-03 Dimensions

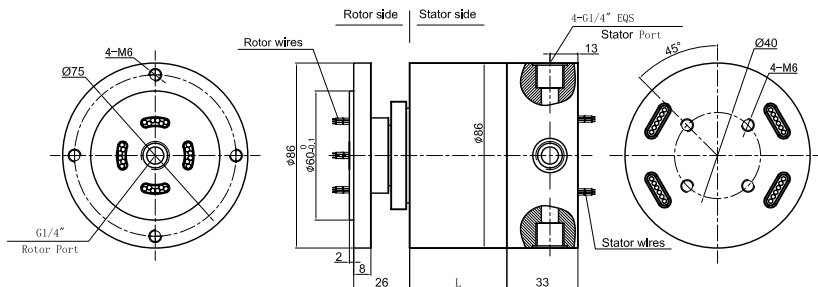

1 inlet 4 outlets , G3/8 Joint MAPH104-04 Dimensions

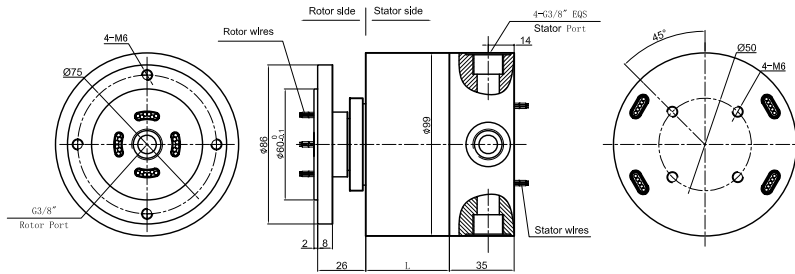

1 inlet 4 outlets , G1/2 Joint MAPH104-05 Dimensions

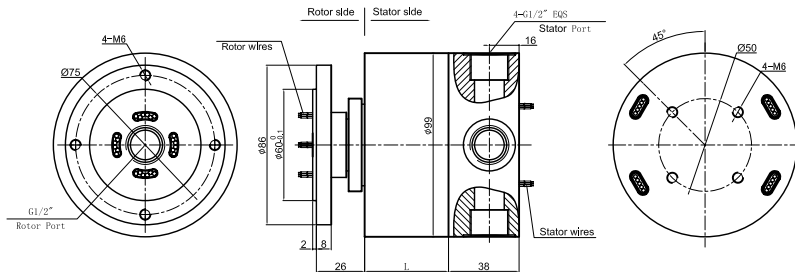

Specifications

Rotary Union Specifications			Mechanical Data	
Parameter	Value		Parameter	Value
Passage	1 inlet 4 outlets		Working life	See Product Quality Level Table
Max Pressure	10MPa; Vacuum 0.01torr		Rotating Speed	See Product Quality Level Table
Torque	depend on conection size		Working Temperature	-30°C~80°C
Electrical Data			Operating Humidity	0~85% RH
Parameter	Value		Contact Material	Precious Metal
	Power	Signal	Housing Material	Aluminium Alloy
Rated Voltage	0~440VAC/VDC	0~440VAC/VDC	Protection Grade	IP51
Insulation Resistance	≥1000MΩ/500VDC	≥1000MΩ/500VDC		
Lead Wires	AWG16#Teflon AWG17#Teflon (MAPH104-01)	AWG22#Teflon		
Lead Length	standard 300mm(adjustable)			
Insulation Strength	500VAC@50Hz,60s			
Electrical Noise	<0.01Ω			

Part# List

MAPH104-01 Pneumatic/Hydraulic Slip Ring
1) XX=01, Connection size=M5' Pipe size3~6mm

Part#	Pneumatic/Hydraulic Passage	10A	Signal 5A	Length (mm)	Part#	Pneumatic/Hydraulic Passage	10A	Signal 5A	Length (mm)
MAPH104-XX-S06	1 Passage	0	6	38	MAPH104-XX-P0810-S10	1 Passage	8	10	71.6
MAPH104-XX-P0210-S04	1 Passage	2	4	38	MAPH104-XX-P1010-S08	1 Passage	10	8	71.6
MAPH104-XX-P0410-S02	1 Passage	4	2	38	MAPH104-XX-P1210-S06	1 Passage	12	6	71.6
MAPH104-XX-P0610	1 Passage	6	0	38	MAPH104-XX-P1410-S04	1 Passage	14	4	71.6
MAPH104-XX-S12	1 Passage	12	0	54.8	MAPH104-XX-P1610-S02	1 Passage	16	2	71.6
MAPH104-XX-P0210-S10	1 Passage	2	10	54.8	MAPH104-XX-S24	1 Passage	0	24	88.4
MAPH104-XX-P0310-S09	1 Passage	3	9	54.8	MAPH104-XX-P0410-S20	1 Passage	4	20	88.4
MAPH104-XX-P0610-S06	1 Passage	6	6	54.8	MAPH104-XX-P0610-S18	1 Passage	6	18	88.4
MAPH104-XX-P0810-S04	1 Passage	8	4	54.8	MAPH104-XX-P1210-S12	1 Passage	12	12	88.4
MAPH104-XX-P1010-S02	1 Passage	10	2	54.8	MAPH104-XX-S30	1 Passage	0	30	105.2
MAPH104-XX-P1210	1 Passage	12	0	54.8	MAPH104-XX-P0610-S24	1 Passage	6	24	105.2
MAPH104-XX-S18	1 Passage	0	18	71.6	MAPH104-XX-S36	1 Passage	0	36	125
MAPH104-XX-P0210-S16	1 Passage	2	16	71.6	MAPH104-XX-S42	1 Passage	0	42	141.8
MAPH104-XX-P0410-S14	1 Passage	4	14	71.6	MAPH104-XX-S48	1 Passage	0	48	158.6
MAPH104-XX-P0610-S12	1 Passage	6	12	71.6					

Note:N channels 10A rings parallel can be used as 1 channel N*10A current. For example: 2 rings 10A parallel could be used as 1 wires 20A.
10A and Signal(5A) can be combine in any way as you need.Max.ring:96 rings,can be customized based on standard slip rings.Please contact us.

Part# List

MAPH104-03, MAPH104-04, MAPH104-05Pneumatic/Hydraulic Slip Ring									
1) XX=03, Connection size=G1/4", Pipe size3~12mm									
2) XX=04, Connection size=G3/8", Pipe size8~16mm									
3) XX=05, Connection size=G1/2", Pipe size10~20mm									
Part#	Pneumatic/Hydraulic Passage	10A	Signal or 5A	Length (mm)	Part#	Pneumatic/Hydraulic Passage	10A	Signal or 5A	Length (mm)
MAPH104-XX-S06	1 Passage	0	6	45.2	MAPH104-XX-S36	1 Passage	0	36	150.2
MAPH104-XX-P0210-S04	1 Passage	2	4	45.2	MAPH104-XX-P0610-S30	1 Passage	6	30	150.2
MAPH104-XX-P0410-S02	1 Passage	4	2	45.2	MAPH104-XX-P1210-S24	1 Passage	12	24	150.2
MAPH104-XX-P0610	1 Passage	6	0	45.2	MAPH104-XX-P3610	1 Passage	36	0	150.2
MAPH104-XX-S12	1 Passage	0	12	65.6	MAPH104-XX-S42	1 Passage	0	42	170.6
MAPH104-XX-P0210-S10	1 Passage	2	10	65.6	MAPH104-XX-P0610-S36	1 Passage	6	36	170.6
MAPH104-XX-P0310-S09	1 Passage	3	9	65.6	MAPH104-XX-P1210-S30	1 Passage	12	30	170.6
MAPH104-XX-P0610-S06	1 Passage	6	6	65.6	MAPH104-XX-P4210	1 Passage	42	0	170.6
MAPH104-XX-P0810-S04	1 Passage	8	4	65.6	MAPH104-XX-S48	1 Passage	0	48	193.2
MAPH104-XX-P1010-S02	1 Passage	10	2	65.6	MAPH100-XX-P0610-S42	1 Passage	6	42	193.2
MAPH104-XX-P1210	1 Passage	12	0	65.6	MAPH104-XX-P1210-S36	1 Passage	12	36	193.2
MAPH104-XX-S18	1 Passage	0	18	86	MAPH104-XX-P1810-S30	1 Passage	18	30	193.2
MAPH104-XX-P0210-S16	1 Passage	2	16	86	MAPH104-XX-P2410-S24	1 Passage	24	24	193.2
MAPH104-XX-P0410-S14	1 Passage	4	14	86	MAPH104-XX-P4810	1 Passage	48	0	193.2
MAPH104-XX-P0610-S12	1 Passage	6	12	86	MAPH104-XX-S60	1 Passage	0	60	234
MAPH104-XX-P0810-S10	1 Passage	8	10	86	MAPH104-XX-P0610-S54	1 Passage	6	54	234
MAPH104-XX-P1010-S08	1 Passage	10	8	86	MAPH104-XX-P0910-S51	1 Passage	9	51	234
MAPH104-XX-P1210-S06	1 Passage	12	6	86	MAPH104-XX-P1210-S48	1 Passage	12	48	234
MAPH104-XX-P1410-S04	1 Passage	14	4	86	MAPH104-XX-P2410-S36	1 Passage	24	36	234
MAPH104-XX-P1610-S02	1 Passage	16	2	86	MAPH104-XX-S72	1 Passage	0	72	277.8
MAPH104-XX-S24	1 Passage	0	24	106.4	MAPH104-XX-P1210-S60	1 Passage	12	60	277.8
MAPH104-XX-P0410-S20	1 Passage	4	20	106.4	MAPH104-XX-P2410-S48	1 Passage	24	48	277.8
MAPH104-XX-P0610-S18	1 Passage	6	18	106.4	MAPH104-XX-P3610-S36	1 Passage	36	36	277.8
MAPH104-XX-P1210-S12	1 Passage	12	12	106.4	MAPH104-XX-P1210-S18	1 Passage	12	18	126.8
MAPH104-XX-P1810-S06	1 Passage	18	6	106.4	MAPH104-XX-P1810-S12	1 Passage	18	12	126.8
MAPH104-XX-P2410	1 Passage	24	0	106.4	MAPH104-XX-P2410-S06	1 Passage	24	6	126.8
MAPH104-XX-S30	1 Passage	0	30	126.8	MAPH104-XX-P3010	1 Passage	30	0	126.8
MAPH104-XX-P0610-S24	1 Passage	6	24	126.8					

Note:N channels 10A rings parallel can be used as 1 channel N*10A current. For example: 2 rings 10A parallel could be used as 1 wires 20A. 10A and Signal(5A) can be combine in any way as you need.Max.ring:96 rings,can be customized based on standard slip rings.Please contact us.

Product Quality Level Table

Products Level Code	Max Rotating Speed	Working Life	Sealing Element
VC	100RPM	10 Million Revs	Common Seals
VD	300RPM	30 Million Revs	High-Quality Seals

Lead Wires Color Code

Ring	1	2	3	4	5	6	7	8	9	10	11	12
Color	BLK	RED	YLW	GRN	BLU	WHT	BLK	RED	YLW	GRN	BLU	WHT

(6 wires for 1 group color, from 7-12, repeat the same color as 1...6, indicated with number code pipe)

Options for custom slip ring

Note:Below special demands can be customized. According, the delivery date will be extended 3 to 15 days; also the cost will be increased 30% to 50%. Most of our basic parts are standard and modular, which can save the cost and lead time.

- ① Cable exit way and cable length can be customized for both rotor and stator.
- ② Because of the structure limitation, length/height/OD can be customized on your request.
- ③ Support current or signal up to 200 rings.
- ④ Aviation plug, terminal and heat-shrink tube are optional.
- ⑤ Hybrid slip ring for Yaskawa/Panasonic/Siemens servo control signal, power line and encoder line.
- ⑥ Support mixed high speed data transmission (including Ethernet, USB, RS232, RS485, Profibus, CanBUS, CANOPEN, DeviceNET, CC-LINK, ProFINET, EtherCAT, etc.)

- ⑦ Can combine temperature control signal with thermocouple signal.
 - ⑧ Special environment can be customized, such as quakeproof, high temperature, etc.
 - ⑨ Hybrid Pneumatic/hydraulic and electric slip ring can be mixed.
 - ⑩ High temperature can up to 500 degrees.
 - ⑪ High voltage can up to 110KV
 - ⑫ Rotating speed can up to 10000RPM
 - ⑬ Maximum current can up to 5000 amperes.
 - ⑭ Military grade
 - ⑮ Optional for underwater IP65, IP68.
 - ⑯ Optional for stainless steel housing
- Technical support technical@moflon.com

MAPH200

2 Passages Fluid Electrical Slip Ring



MAPH200 is 2 passages Pneumatic/Hydraulic + 2~96rings Electrical Slip Ring.
 Connection size including: M5,G1/8", G1/4", G3/8",G1/2" and bigger on request.
 Electrical rings including power wire, signal wire,Ethernet, USB, Industrial BUS, control Net, and all kinds of sensitive signal, etc. Normally use flange for installation, hollow shaft intallation on request.
 Media Types: Air/Gas,hydrogen,Nitrogen,Chemical, Water,Oil,etc.

Part# Explanation

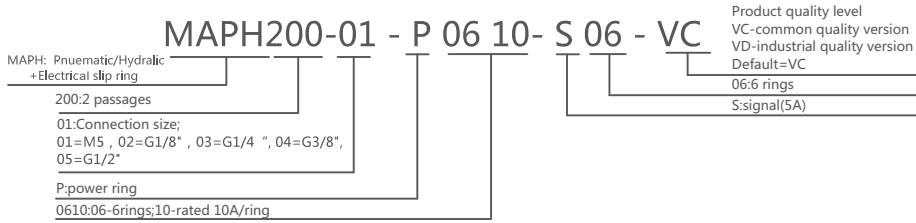

2 passages , M5 MAPH200-01 Dimensions

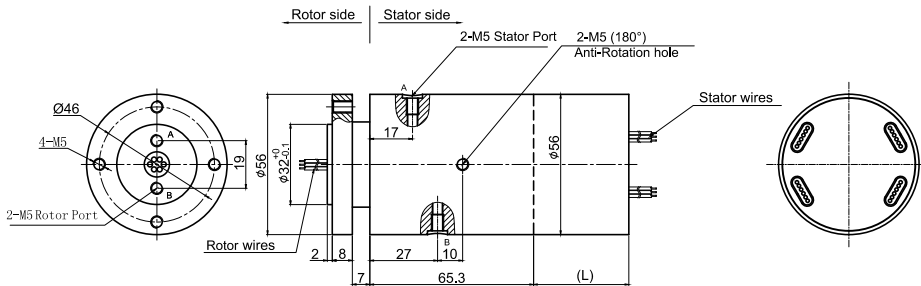

2 passages , G1/8 MAPH200-02 Dimensions

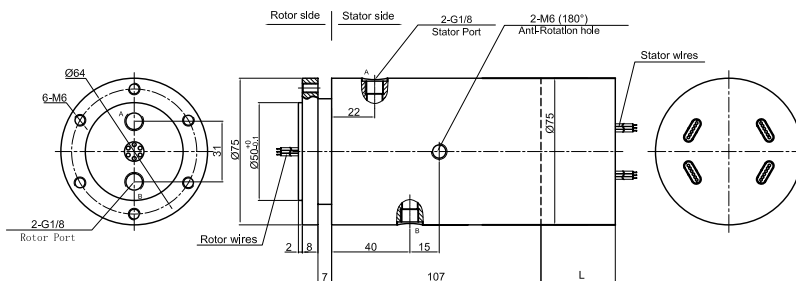

2 passages , G1/4 MAPH200-03 Dimensions

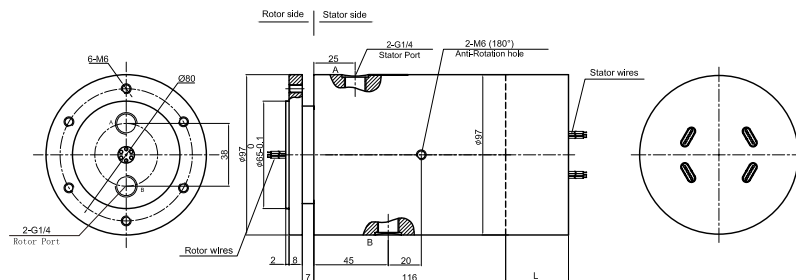

2 passages , G3/8 MAPH200-04 Dimensions

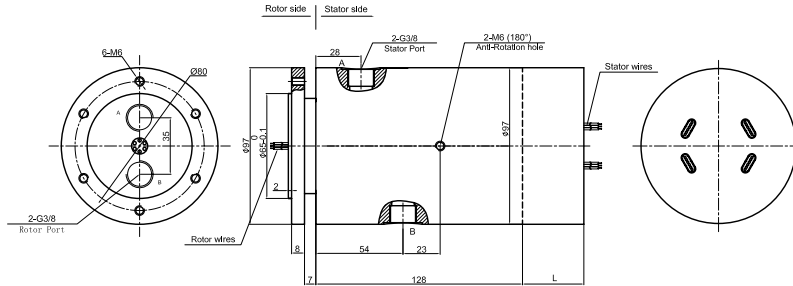

2 passages , G1/2 MAPH200-05 Dimensions

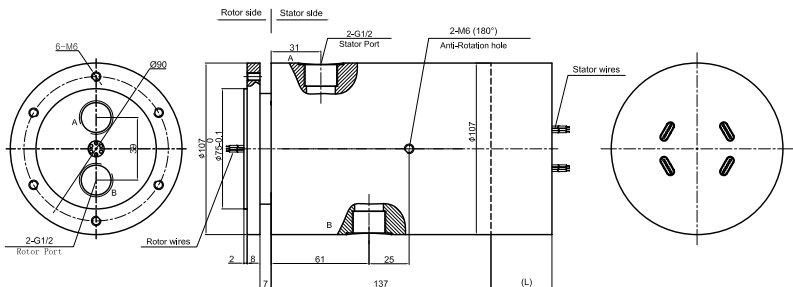

Specifications

Rotary Union Specification		
Parameter	Value	
Passage	2 passages	
Max. Pressure	10MPa , Vacuum 0.01torr	
Torque	depend on conection size	
Electrical Data		
Parameter	Value	
	Power	Signal
Rated Voltage	0~440VAC/VDC	0~440VAC/VDC
Insulation Resistance	≥1000MΩ/500VDC	≥1000MΩ/500VDC
Lead Wires	AWG17#Teflon	AWG22#Teflon
Lead Length	standard 300mm(adjustable)	
Insulation Strength	500VAC@50Hz , 60s	
Electrical Noise	<0.01Ω	
Mechanical Data		
Parameter	Value	
Working Life	See Product Quality Level Table	
Rotating Speed	See Product Quality Level Table	
Working Temperature	-30°C~80°C	
Operating Humidity	0~85% RH	
Contact Material	Precious Metal	
Housing Material	Aluminium Alloy	
Protection Grade	IP51	

Part# List

MAPH200-XX Pneumatic/Hydraulic Slip Ring

1) XX=01,connection size=M5" , Pipe size3~6mm 2) XX=02,connection size=G1/8",Pipe size3~10mm
 3) XX=03,connection size=G1/4" , Pipe size3~12mm 4) XX=04,connection size=G3/8",Pipe size3~16mm
 5) XX=05,connection size=G1/2",Pipe size3~20mm

Part#	Pneumatic/Hydraulic Passage	10A	Signal or 5A	Length (mm)	Part#	Pneumatic/Hydraulic Passage	10A	Signal or 5A	Length (mm)
MAPH200-XX-S06	2 passages	0	6	38	MAPH200-XX-P1210-S06	2 passages	12	6	71.6
MAPH200-XX-P0210-S04	2 passages	2	4	38	MAPH200-XX-P1410-S04	2 passages	14	4	71.6
MAPH200-XX-P0410-S02	2 passages	4	2	38	MAPH200-XX-P1610-S02	2 passages	16	2	71.6
MAPH200-XX-P0610	2 passages	6	0	38	MAPH200-XX-S24	2 passages	0	24	88.4
MAPH200-XX-S12	2 passages	12	0	54.8	MAPH200-XX-P0410-S20	2 passages	4	20	88.4
MAPH200-XX-P0210-S10	2 passages	2	10	54.8	MAPH200-XX-P0610-S18	2 passages	6	18	88.4
MAPH200-XX-P0310-S09	2 passages	3	9	54.8	MAPH200-XX-P1210-S12	2 passages	12	12	88.4
MAPH200-XX-P0610-S06	2 passages	6	6	54.8	MAPH200-XX-S30	2 passages	0	30	105.2
MAPH200-XX-P0810-S04	2 passages	8	4	54.8	MAPH200-XX-P0610-S24	2 passages	6	24	105.2
MAPH200-XX-P1010-S02	2 passages	10	2	54.8	MAPH200-XX-S36	2 passages	0	36	125
MAPH200-XX-P1210	2 passages	12	0	54.8	MAPH200-XX-S42	2 passages	0	42	141.8
MAPH200-XX-S18	2 passages	0	18	71.6	MAPH200-XX-S48	2 passages	0	48	158.6
MAPH200-XX-P0210-S16	2 passages	2	16	71.6					
MAPH200-XX-P0410-S14	2 passages	4	14	71.6					
MAPH200-XX-P0610-S12	2 passages	6	12	71.6					
MAPH200-XX-P0810-S10	2 passages	8	10	71.6					
MAPH200-XX-P1010-S08	2 passages	10	8	71.6					

Note:N channels 10A rings parallel can be used as 1 channel N*10A current. For example: 2 rings 10A parallel could be used as 1 wires 20A.
 10A and Signal(5A) can be combine in any way as you need.Max.ring:96 rings,can be customized based on standard slip rings.Please contact us.

Product Quality Level Table

Products Level Code	Max Rotating Speed	Working Life	Sealing Element
VC	100RPM	10 Million Revs	Common Seals
VD	300RPM	30 Million Revs	High-Quality Seals

Lead Wires Color Code

Ring	1	2	3	4	5	6	7	8	9	10	11	12
Color	BLK	RED	YLW	GRN	BLU	WHT	BLK	RED	YLW	GRN	BLU	WHT

(6 wires for 1 group color, from 7-12, repeat the same color as 1...6, indicated with number code pipe)

Options for custom slip ring

Note: Below special demands can be customized. According, the delivery date will be extended 3 to 15 days; also the cost will be increased 30% to 50%. Most of our basic parts are standard and modular, which can save the cost and lead time.

- ① Cable exit way and cable length can be customized for both rotor and stator.
- ② Because of the structure limitation, length/height/OD can be customized on your request.
- ③ Support current or signal up to 200 rings.
- ④ Aviation plug, terminal and heat-shrink tube are optional.
- ⑤ Hybrid slip ring for Yaskawa/Panasonic/Siemens servo control signal, power line and encoder line.
- ⑥ Support mixed high speed data transmission (including Ethernet, USB, RS232, RS485, Profibus, CanBUS, CANOPEN, DeviceNET, CC-LINK, ProfiNET, EtherCAT, etc.)
- ⑦ Can combine temperature control signal with thermocouple signal.
- ⑧ Special environment can be customized, such as quakeproof, high temperature, etc.
- ⑨ Hybrid Pneumatic/hydraulic and electric slip ring can be mixed.
- ⑩ High temperature can up to 500 degrees.
- ⑪ High pressure can up to 110KV
- ⑫ Rotating speed can up to 10000RPM
- ⑬ Maximum current can up to 5000 amperes.
- ⑭ Military grade
- ⑮ Optional for underwater IP65, IP68.
- ⑯ Optional for stainless steel housing

Technical support: technical@moflon.com

MAPH200F

2 Passages Fluid Electrical Slip Ring



MAPH200F is 2 passages Pneumatic /Hydraulic + 2~96rings Electrical Slip Ring.
 Connection size including: M5,G1/8", G1/4", G3/8",G1/2" and bigger on request.
 Electrical rings including power wire, signal wire,Ethernet, USB, Industrial BUS, control Net, and all kinds of sensitive signal, etc. Normally use flange for installation, hollow shaft intallation on request.
 Media Types: Air/Gas,hydrogen,Nitrogen,Chemical, Water,Oil,etc.

Part# Explanation

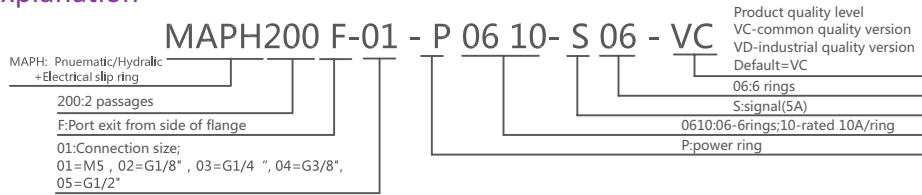

2 passages , M5 Joint MAPH200F-01 Dimensions

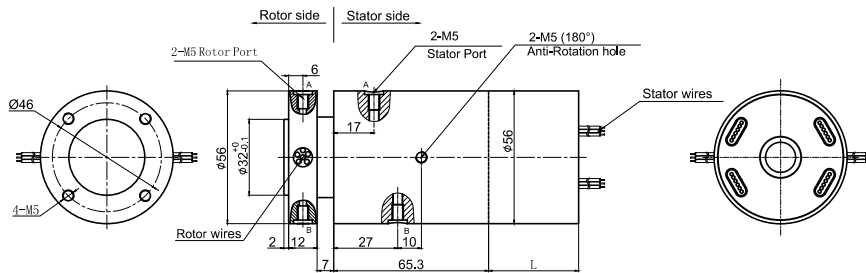

2 passages , G1/8 Joint MAPH200F-02 Dimensions

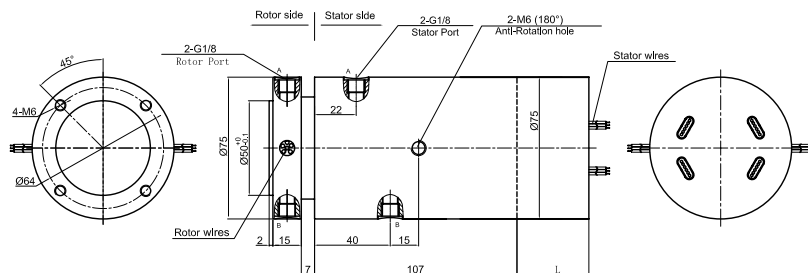

2 passages , G1/4 Joint MAPH200F-03 Dimensions

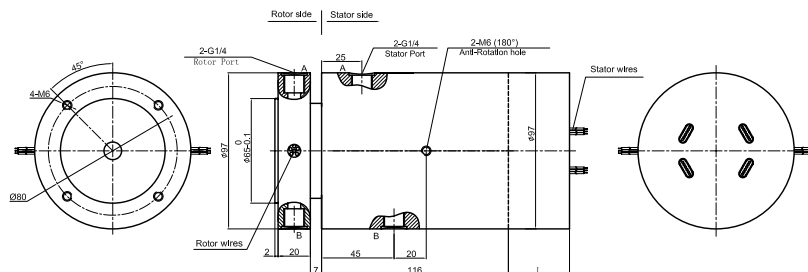

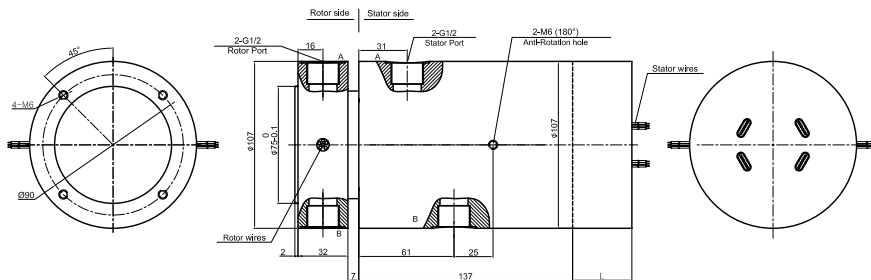
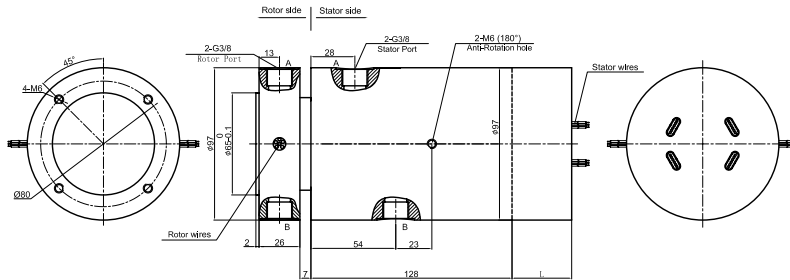

Specifications

Rotary Union Specification		
Parameter	Value	
Passage	2 passages	
Max .Pressure	10MPa , Vacuum 0.01torr	
Torque	depend on conection size	
Electrical Data		
Parameter	Value	
	Power	Signal
Rated Voltage	0~440VAC/VDC	0~440VAC/VDC
Insulation Resistance	≥1000MΩ/500VDC	≥1000MΩ/500VDC
Lead Wires	AWG16#Teflon; AWG17#(MAPH200F-01)	AWG22#Teflon
Lead Length	standard 300mm(adjustable)	
Insulation Strength	500VAC@50Hz , 60s	
Electrical Noise	<0.01Ω	
Mechanical Data		
Parameter	Value	
Working Life	See Product Quality Level Table	
Rotating Speed	See Product Quality Level Table	
Working Temperature	-30°C~80°C	
Operating Humidity	0~85% RH	
Contact Material	Precious Metal	
Housing Material	Aluminium Alloy	
Protection Grade	IP51	

Part# List

MAPH200F-XX Pneumatic/Hydraulic Slip Ring

1) XX=01,connection size=M5", Pipe size3~6mm 2) XX=02,connection size=G1/8",Pipe size3~10mm
 3) XX=03,connection size=G1/4",Pipe size3~12mm 4) XX=04,connection size=G3/8",Pipe size3~16mm
 5) XX=05,connection size=G1/2",Pipe size3~20mm

Part#	Pneumatic/Hydraulic Passage	10A	Signal or 5A	Length (mm)	Part#	Pneumatic/Hydraulic Passage	10A	Signal or 5A	Length (mm)
MAPH200F-XX-S06	2 passages	0	6	38	MAPH200F-XX-P1210-S06	2 passages	12	6	71.6
MAPH200F-XX-P0210-S04	2 passages	2	4	38	MAPH200F-XX-P1410-S04	2 passages	14	4	71.6
MAPH200F-XX-P0410-S02	2 passages	4	2	38	MAPH200F-XX-P1610-S02	2 passages	16	2	71.6
MAPH200F-XX-P0610	2 passages	6	0	38	MAPH200F-XX-S24	2 passages	0	24	88.4
MAPH200F-XX-S12	2 passages	12	0	54.8	MAPH200F-XX-P0410-S20	2 passages	4	20	88.4
MAPH200F-XX-P0210-S10	2 passages	2	10	54.8	MAPH200F-XX-P0610-S18	2 passages	6	18	88.4
MAPH200F-XX-P0310-S09	2 passages	3	9	54.8	MAPH200F-XX-P1210-S12	2 passages	12	12	88.4
MAPH200F-XX-P0610-S06	2 passages	6	6	54.8	MAPH200F-XX-S30	2 passages	0	30	105.2
MAPH200F-XX-P0810-S04	2 passages	8	4	54.8	MAPH200F-XX-P0610-S24	2 passages	6	24	105.2
MAPH200F-XX-P1010-S02	2 passages	10	2	54.8	MAPH200F-XX-S36	2 passages	0	36	125
MAPH200F-XX-P1210	2 passages	12	0	54.8	MAPH200F-XX-S42	2 passages	0	42	141.8
MAPH200F-XX-S18	2 passages	0	18	71.6	MAPH200F-XX-S48	2 passages	0	48	158.6
MAPH200F-XX-P0210-S16	2 passages	2	16	71.6					
MAPH200F-XX-P0410-S14	2 passages	4	14	71.6					
MAPH200F-XX-P0610-S12	2 passages	6	12	71.6					
MAPH200F-XX-P0810-S10	2 passages	8	10	71.6					
MAPH200F-XX-P1010-S08	2 passages	10	8	71.6					

Note:N channels 10A rings parallel can be used as 1 channel N*10A current. For example: 2 rings 10A parallel could be used as 1 wires 20A
 10A and Signal(5A) can be combine in any way as you need.Max.ring:96 rings,can be customized based on standard slip rings.Please contact us.

Product Quality Level Table

Products Level Code	Max Rotating Speed	Working Life	Sealing Element
VC	100RPM	10 Million Revs	Common Seals
VD	300RPM	30 Million Revs	High-Quality Seals

Lead Wires Color Code

Ring	1	2	3	4	5	6	7	8	9	10	11	12
Color	BLK	RED	YLW	GRN	BLU	WHT	BLK	RED	YLW	GRN	BLU	WHT

(6 wires for 1 group color, from 7-12, repeat the same color as 1...6, indicated with number code pipe)

Options for custom slip ring

Note: Below special demands can be customized. According, the delivery date will be extended 3 to 15 days; also the cost will be increased 30% to 50%. Most of our basic parts are standard and modular, which can save the cost and lead time.

- ① Cable exit way and cable length can be customized for both rotor and stator.
- ② Because of the structure limitation, length/height/OD can be customized on your request.
- ③ Support current or signal up to 200 rings.
- ④ Aviation plug, terminal and heat-shrink tube are optional.
- ⑤ Hybrid slip ring for Yaskawa/Panasonic/Siemens servo control signal, power line and encoder line.
- ⑥ Support mixed high speed data transmission (including Ethernet, USB, RS232, RS485, Profibus, CanBUS, CANOPEN, DeviceNET, CC-LINK, ProfiNET, EtherCAT, etc.)
- ⑦ Can combine temperature control signal with thermocouple signal.
- ⑧ Special environment can be customized, such as quakeproof, high temperature, etc.
- ⑨ Hybrid Pneumatic/hydraulic and electric slip ring can be mixed.
- ⑩ High temperature can up to 500 degrees.
- ⑪ High pressure can up to 110KV
- ⑫ Rotating speed can up to 10000RPM
- ⑬ Maximum current can up to 5000 amperes.
- ⑭ Military grade
- ⑮ Optional for underwater IP65, IP68.
- ⑯ Optional for stainless steel housing

Technical support: technical@moflon.com

MAPH200W

Double Flange ,2 Passages Fluid Electrical Slip Ring



MAPH200W is 2 passages Pneumatic /Hydraulic + 2~96rings Electrical Slip Ring.
 Connection size including: M5,G1/8", G1/4", G3/8",G1/2" and bigger on request.
 Electrical rings including power wire, signal wire,Ethernet, USB, Industrial BUS, control Net, and all kinds of sensitive signal, etc. Normally use flange for installation, hollow shaft intallation on request.
 Media Types: Air/Gas,hydrogen,Nitrogen,Chemical, Water,Oil,etc.

Part# Explanation

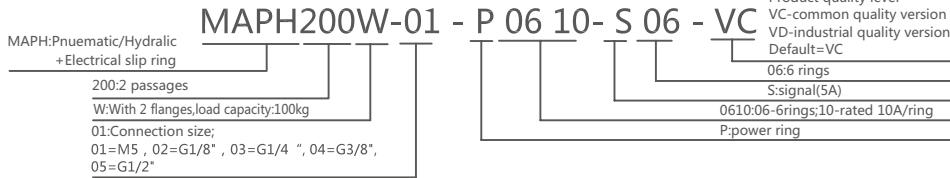

2 passages , G1/8

MAPH200W-02 Dimensions

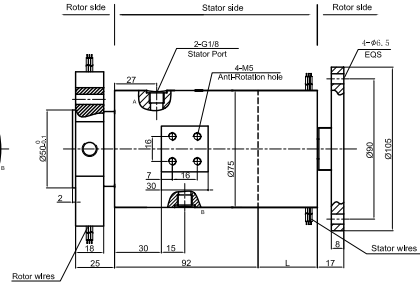
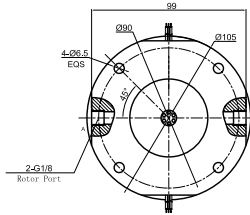
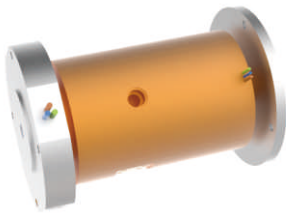

2 passages , G1/4

MAPH200W-03 Dimensions

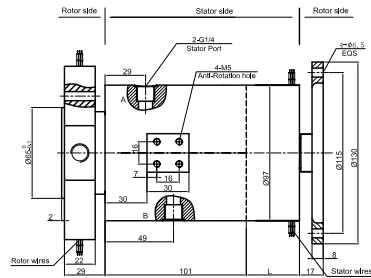
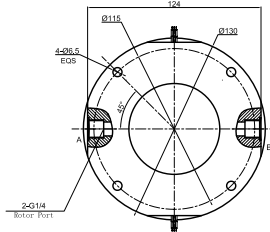
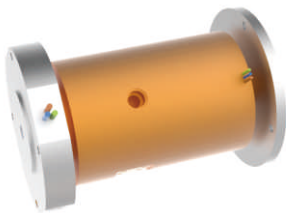

Specifications

Rotary Union Specifications			Mechanical Data	
Parameter	Value		Parameter	Value
Passage	2 passages		Working life	See Product Quality Level Table
Max Pressure	10MPa , Vacuum 0.01torr		Rotating Speed	See Product Quality Level Table
Torque	depend on cnection size		Working Temperature	-30°C ~80°C
Electrical Data			Operating Humidity	0~85% RH
Parameter	Value		Contact Material	Precious Metal
	Power	Signal	Housing Material	Aluminium Alloy
Rated Voltage	0~440VAC/VDC	0~440VAC/VDC	Protection Grade	IP51
Insulation Resistance	≥1000MΩ/500VDC	≥1000MΩ/500VDC		
Lead Wires	AWG17#Teflon	AWG22#Teflon		
Lead Length	standard 300mm(adjustable)			
Insulation Strength	500VAC@50Hz , 60s			
Electrical Noise	<0.01Ω			

Part# List

MAPH200W-XX Pneumatic/Hydraulic Slip Ring									
1) XX=01,connection size=M5 Pipe size3~6mm 2) XX=02,connection size=G1/8" Pipe size3~10mm									
3) XX=03,connection size=G1/4", Pipe size3~12mm 4) XX=04,connection size=G3/8" Pipe size3~16mm									
5) XX=05,connection size=G1/2", Pipe size3~20mm									
Part#	Pneumatic/Hydraulic Passage	10A	Signal or 5A	Length (mm)	Part#	Pneumatic/Hydraulic Passage	10A	Signal or 5A	Length (mm)
MAPH200W-XX-S06	2 passages	0	6	38	MAPH200W-XX-P0810-S10	2 passages	8	10	71.6
MAPH200W-XX-P0210-S04	2 passages	2	4	38	MAPH200W-XX-P1010-S08	2 passages	10	8	71.6
MAPH200W-XX-P0410-S02	2 passages	4	2	38	MAPH200W-XX-P1210-S06	2 passages	12	6	71.6
MAPH200W-XX-P0610	2 passages	6	0	38	MAPH200W-XX-P1410-S04	2 passages	14	4	71.6
MAPH200W-XX-S12	2 passages	12	0	54.8	MAPH200W-XX-P1610-S02	2 passages	16	2	71.6
MAPH200W-XX-P0210-S10	2 passages	2	10	54.8	MAPH200W-XX-S24	2 passages	0	24	88.4
MAPH200W-XX-P0310-S09	2 passages	3	9	54.8	MAPH200W-XX-P0410-S20	2 passages	4	20	88.4
MAPH200W-XX-P0610-S06	2 passages	6	6	54.8	MAPH200W-XX-P0610-S18	2 passages	6	18	88.4
MAPH200W-XX-P0810-S04	2 passages	8	4	54.8	MAPH200W-XX-P1210-S12	2 passages	12	12	88.4
MAPH200W-XX-P1010-S02	2 passages	10	2	54.8	MAPH200W-XX-S30	2 passages	0	30	105.2
MAPH200W-XX-P1210	2 passages	12	0	54.8	MAPH200W-XX-P0610-S24	2 passages	6	24	105.2
MAPH200W-XX-S18	2 passages	0	18	71.6	MAPH200W-XX-S36	2 passages	0	36	125
MAPH200W-XX-P0210-S16	2 passages	2	16	71.6	MAPH200W-XX-S42	2 passages	0	42	141.8
MAPH200W-XX-P0410-S14	2 passages	4	14	71.6	MAPH200W-XX-S48	2 passages	0	48	158.6
MAPH200W-XX-P0610-S12	2 passages	6	12	71.6					

Note:N channels 10A rings parallel can be used as 1 channel N*10A current. For example: 2 rings 10A parallel could be used as 1 wires 20A
10A and Signal(5A) can be combine in any way as you need.Max.ring:96 rings,can be customized based on standard slip rings.Please contact us.

Product Quality Level Table

Products Level Code	Max Rotating Speed	Working Life	Sealing Element
VC	100RPM	10 Million Revs	Common Seals
VD	300RPM	30 Million Revs	High-Quality Seals

Lead Wires Color Code

Ring	1	2	3	4	5	6	7	8	9	10	11	12
Color	BLK	RED	YLW	GRN	BLU	WHT	BLK	RED	YLW	GRN	BLU	WHT

(6 wires for 1 group color, from 7-12, repeat the same color as 1...6, indicated with number code pipe)

Options for custom slip ring

Note: Below special demands can be customized. According, the delivery date will be extended 3 to 15 days; also the cost will be increased 30% to 50%. Most of our basic parts are standard and modular, which can save the cost and lead time.

- ① Cable exit way and cable length can be customized for both rotor and stator.
- ② Because of the structure limitation, length/height/OD can be customized on your request.
- ③ Support current or signal up to 200 rings.
- ④ Aviation plug, terminal and heat-shrink tube are optional.
- ⑤ Hybrid slip ring for Yaskawa/Panasonic/Siemens servo control signal, power line and encoder line.
- ⑥ Support mixed high speed data transmission (including Ethernet, USB, RS232, RS485, Profibus, CanBUS, CANOPEN, DeviceNET, CC-LINK, ProfiNET, EtherCAT, etc.)
- ⑦ Can combine temperature control signal with thermocouple signal.
- ⑧ Special environment can be customized, such as quakeproof, high temperature, etc.
- ⑨ Hybrid Pneumatic/hydraulic and electric slip ring can be mixed.
- ⑩ High temperature can up to 500 degrees.
- ⑪ High pressure can up to 110KV
- ⑫ Rotating speed can up to 10000RPM
- ⑬ Maximum current can up to 5000 amperes.
- ⑭ Military grade
- ⑮ Optional for underwater IP65, IP68.
- ⑯ Optional for stainless steel housing

Technical support: technical@moflon.com

MAPH200S

2 Passages Fluid Electrical Slip Ring



MAPH200S is 2 passages Pneumatic /Hydraulic + 2~96rings Electrical Slip Ring.
 Connection size including: M5,G1/8", G1/4", G3/8",G1/2" and bigger on request.
 Electrical rings including power wire, signal wire,Ethernet, USB, Industrial BUS, control Net, and all kinds of sensitive signal, etc. Normally use flange for installation, hollow shaft intallation on request.
 Media Types: Air/Gas,hydrogen,Nitrogen,Chemical, Water,Oil,etc.

Part# Explanation

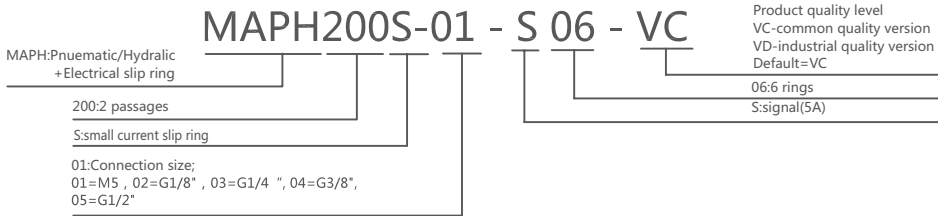

2 passages , M5 Joint MAPH200S-01 Dimensions

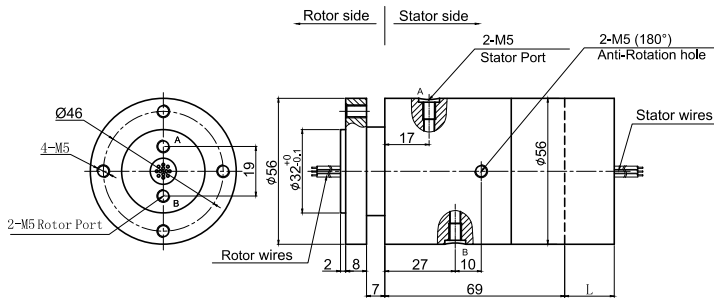

2 passages , G1/8 Joint MAPH200S-02 Dimensions

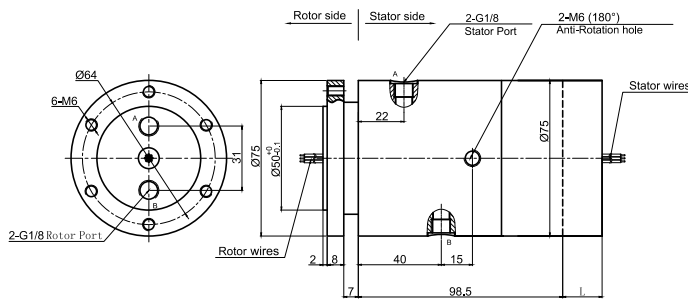

2 passages , G1/4 Joint MAPH200S-03 Dimensions

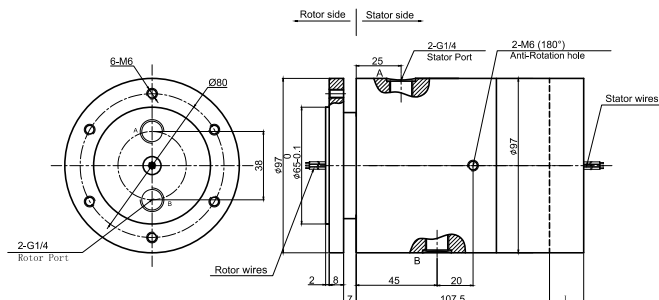

2 passages , G3/8 Joint MAPH200S-04 Dimensions

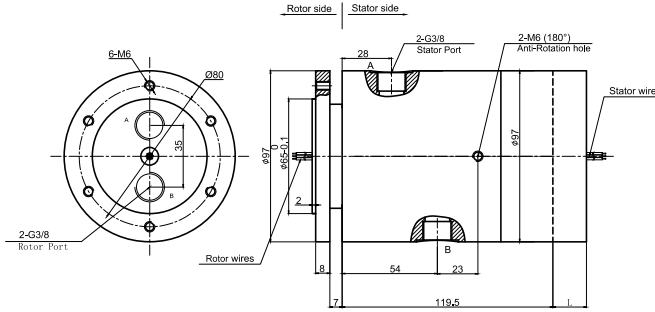

2 passages , G1/2 Joint MAPH200S-05 Dimensions

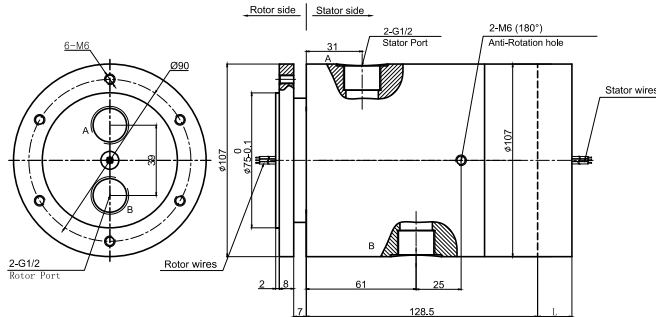

Specifications

Rotary Union Specification		
Parameter	Value	
Passage	2 passages	
Max .Pressure	10MPa , Vacuum 0.01torr	
Torque	depend on conection size	
Electrical Data		
Parameter	Value	
	Power	Signal
Rated Voltage	0~240VAC/VDC	0~240VAC/VDC
Insulation Resistance	$\geq 1000M\Omega/500VDC$	$\geq 1000M\Omega/500VDC$
Lead Wires	AWG28#Teflon	AWG28#Teflon
Lead Length	standard 300mm(adjustable)	
Insulation Strength	500VAC@50Hz , 60s	
Electrical Noise	$< 0.01\Omega$	
Mechanical Data		
Parameter	Value	
Working Life	See Product Quality Level Table	
Rotating Speed	See Product Quality Level Table	
Working Temperature	$-30^{\circ}C \sim 80^{\circ}C$	
Operating Humidity	0~85% RH	
Contact Material	Precious Metal	
Housing Material	Aluminium Alloy	
Protection Grade	IP51	

Product Quality Level Table

Products Level Code	Max Rotating Speed	Working Life	Sealing Element
VC	100RPM	10 Million Revs	Common Seals
VD	300RPM	30 Million Revs	High-Quality Seals

Lead Wires Color Code

Ring	1	2	3	4	5	6	7	8	9	10	11	12
Color	RED	GRN	YLW	VLV	GRY	BLK	BLU	DK BL	BN	OG	WHT	OCH

(6 wires for 1 group color, from 7-12, repeat the same color as 1...6, indicated with number code pipe)

Part# List

MAPH200S-XX Pneumatic/Hydraulic Slip Ring				
1) XX=01,connection size=M5 , Pipe size3~6mm 2) XX=02,connection size=G1/8 , Pipe size3~10mm				
3) XX=03,connection size=G1/4 , Pipe size3~12mm 4) XX=04,connection size=G3/8 , Pipe size3~16mm				
5) XX=05,connection size=G1/2 , Pipe size3~20mm				
Part#	Pneumatic/Hydraulic Passage	10A	Signal or 2A	Length (mm)
MAPH200S-XX-S06	2 passages	0	6	19
MAPH200S-XX-S12	2 passages	0	12	26
MAPH200S-XX-S18	2 passages	0	18	33
MAPH200S-XX-S24	2 passages	0	24	43.6
MAPH200S-XX-S36	2 passages	0	36	57.3
MAPH200S-XX-S56	2 passages	0	56	85.7

Note:N channels 10A rings parallel can be used as 1 channel N*10A current. For example: 2 rings 10A parallel could be used as 1 wires 20A.

10A and Signal(5A) can be combine in any way as you need.Max.ring:96 rings,can be customized based on standard slip rings.Please contact us.

Options for custom slip ring

Note: Below special demands can be customized. According, the delivery date will be extended 3 to 15 days; also the cost will be increased 30% to 50%. Most of our basic parts are standard and modular, which can save the cost and lead time.

- ① Cable exit way and cable length can be customized for both rotor and stator.
- ② Because of the structure limitation, length/height/OD can be customized on your request.
- ③ Support current or signal up to 200 rings.
- ④ Aviation plug, terminal and heat-shrink tube are optional.
- ⑤ Hybrid slip ring for Yaskawa/Panasonic/Siemens servo control signal, power line and encoder line.
- ⑥ Support mixed high speed data transmission (including Ethernet, USB, RS232, RS485, Profibus, CanBUS, CANOPEN, DeviceNET, CC-LINK, ProfiNET, EtherCAT, etc.)
- ⑦ Can combine temperature control signal with thermocouple signal.
- ⑧ Special environment can be customized, such as quakeproof, high temperature, etc.
- ⑨ Hybrid Pneumatic/hydraulic and electric slip ring can be mixed.
- ⑩ High temperature can up to 500 degrees.
- ⑪ High pressure can up to 110KV
- ⑫ Rotating speed can up to 10000RPM
- ⑬ Maximum current can up to 5000 amperes.
- ⑭ Military grade
- ⑮ Optional for underwater IP65, IP68.
- ⑯ Optional for stainless steel housing

Technical support: technical@moflon.com

MAPH300

3 Passages Fluid Electrical Slip Ring



MAPH300 is 3 passages Pneumatic /Hydraulic + 2~96rings Electrical Slip Ring.
 Connection size including: M5,G1/8", G1/4", G3/8",G1/2" and bigger on request.
 Electrical rings including power wire, signal wire,Ethernet, USB, Industrial BUS, control Net, and all kinds of sensitive signal, etc. Normally use flange for installation, hollow shaft intallation on request.
 Media Types: Air/Gas,hydrogen,Nitrogen,Chemical, Water,Oil,etc.

Part# Explanation

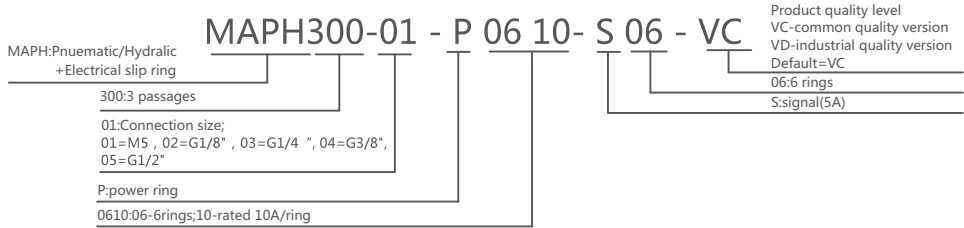

3 passages , M5 MAPH300-01 Dimensions

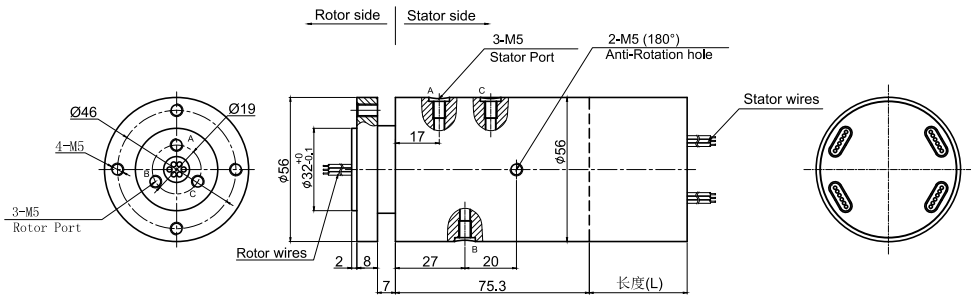

3 passages , G1/8 MAPH300-02 Dimensions

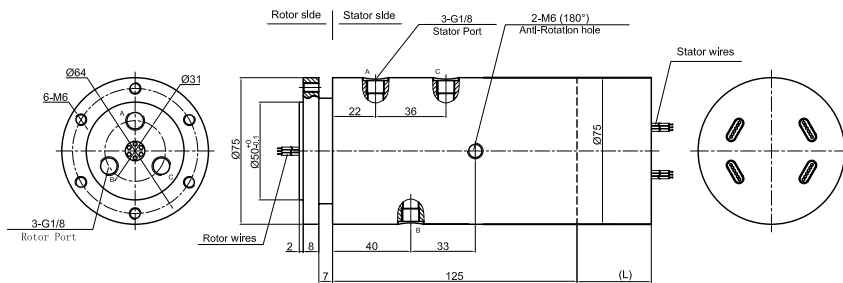

3 passages , G1/4 MAPH300-03 Dimensions

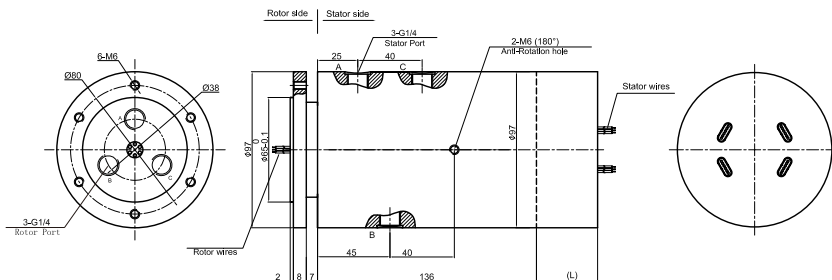

3 passages , G3/8 MAPH300-04 Dimensions

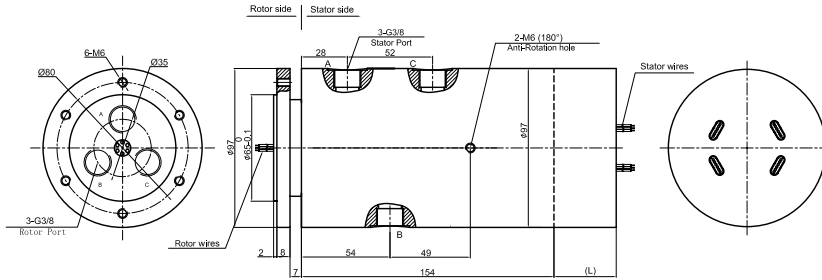

3 passages , G1/2 MAPH300-05 Dimensions

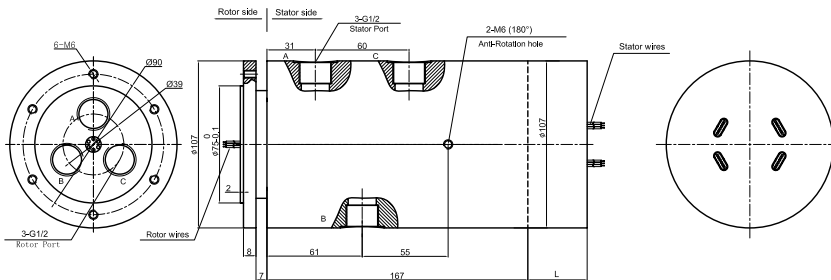

Specifications

Rotary Union Specification			
Parameter	Value		
Passage	3 passages		
Max .Pressure	10MPa , Vacuum 0.01torr		
Torque	depend on conection size		
Electrical Data			
Parameter	Value		
	Power	Signal	
Rated Voltage	0~440VAC/VDC	0~440VAC/VDC	
Insulation Resistance	≥1000MΩ/500VDC	≥1000MΩ/500VDC	
Lead Wires	AWG17#Teflon	AWG22#Teflon	
Lead Length	standard 300mm(adjustable)		
Insulation Strength	500VAC@50Hz , 60s		
Electrical Noise	<0.01Ω		
Mechanical Data			
Parameter	Value		
Working Life	See Product Quality Level Table		
Rotating Speed	See Product Quality Level Table		
Working Temperature	-30°C~80°C		
Operating Humidity	0~85% RH		
Contact Material	Precious Metal		
Housing Material	Aluminium Alloy		
Protection Grade	IP51		

Part# List

MAPH300-XX Pneumatic/Hydraulic Slip Ring
 1) XX=01,connection size=M5 , Pipe size3~6mm 2) XX=02connection size=G1/8" , Pipe size3~10mm
 3) XX=03,connection size=G1/4" , Pipe size3~12mm 4) XX=04,connection size=G3/8" , Pipe size3~16mm
 5) XX=05,connection size=G1/2" , Pipe size3~20mm

Part#	Pneumatic/Hydraulic Passage	10A	Signal or 5A	Length (mm)	Part#	Pneumatic/Hydraulic Passage	10A	Signal or 5A	Length (mm)
MAPH300-XX-S06	3 passages	0	6	38	MAPH300-XX-P1210-S06	3 passages	12	6	71.6
MAPH300-XX-P0210-S04	3 passages	2	4	38	MAPH300-XX-P1410-S04	3 passages	14	4	71.6
MAPH300-XX-P0410-S02	3 passages	4	2	38	MAPH300-XX-P1610-S02	3 passages	16	2	71.6
MAPH300-XX-P0610	3 passages	6	0	38	MAPH300-XX-S24	3 passages	0	24	88.4
MAPH300-XX-S12	3 passages	12	0	54.8	MAPH300-XX-P0410-S20	3 passages	4	20	88.4
MAPH300-XX-P0210-S10	3 passages	2	10	54.8	MAPH300-XX-P0610-S18	3 passages	6	18	88.4
MAPH300-XX-P0310-S09	3 passages	3	9	54.8	MAPH300-XX-P1210-S12	3 passages	12	12	88.4
MAPH300-XX-P0610-S06	3 passages	6	6	54.8	MAPH300-XX-S30	3 passages	0	30	105.2
MAPH300-XX-P0810-S04	3 passages	8	4	54.8	MAPH300-XX-P0610-S24	3 passages	6	24	105.2
MAPH300-XX-P1010-S02	3 passages	10	2	54.8	MAPH300-XX-S36	3 passages	0	36	125
MAPH300-XX-P1210	3 passages	12	0	54.8	MAPH300-XX-S42	3 passages	0	42	141.8
MAPH300-XX-S18	3 passages	0	18	71.6					
MAPH300-XX-P0210-S16	3 passages	2	16	71.6					
MAPH300-XX-P0410-S14	3 passages	4	14	71.6					
MAPH300-XX-P0610-S12	3 passages	6	12	71.6					
MAPH300-XX-P0810-S10	3 passages	8	10	71.6					
MAPH300-XX-P1010-S08	3 passages	10	8	71.6					

Note:N channels 10A rings parallel can be used as 1 channel N*10A current. For example: 2 rings 10A parallel could be used as 1 wires 20A
 10A and Signal(5A) can be combine in any way as you need.Max.ring:96 rings,can be customized based on standard slip rings.Please contact us.

Product Quality Level Table

Products Level Code	Max Rotating Speed	Working Life	Sealing Element
VC	100RPM	10 Million Revs	Common Seals
VD	300RPM	30 Million Revs	High-Quality Seals

Lead Wires Color Code

Ring	1	2	3	4	5	6	7	8	9	10	11	12
Color	BLK	RED	YLW	GRN	BLU	WHT	BLK	RED	YLW	GRN	BLU	WHT

(6 wires for 1 group color, from 7-12, repeat the same color as 1...6, indicated with number code pipe)

Options for custom slip ring

Note: Below special demands can be customized. According, the delivery date will be extended 3 to 15 days; also the cost will be increased 30% to 50%. Most of our basic parts are standard and modular, which can save the cost and lead time.

- ① Cable exit way and cable length can be customized for both rotor and stator.
- ② Because of the structure limitation, length/height/OD can be customized on your request.
- ③ Support current or signal up to 200 rings.
- ④ Aviation plug, terminal and heat-shrink tube are optional.
- ⑤ Hybrid slip ring for Yaskawa/Panasonic/Siemens servo control signal, power line and encoder line.
- ⑥ Support mixed high speed data transmission (including Ethernet, USB, RS232, RS485, Profibus, CanBUS, CANOPEN, DeviceNET, CC-LINK, ProfiNET, EtherCAT, etc.)
- ⑦ Can combine temperature control signal with thermocouple signal.
- ⑧ Special environment can be customized, such as quakeproof, high temperature, etc.
- ⑨ Hybrid Pneumatic/hydraulic and electric slip ring can be mixed.
- ⑩ High temperature can up to 500 degrees.
- ⑪ High pressure can up to 110KV
- ⑫ Rotating speed can up to 10000RPM
- ⑬ Maximum current can up to 5000 amperes.
- ⑭ Military grade
- ⑮ Optional for underwater IP65, IP68.
- ⑯ Optional for stainless steel housing

Technical support: technical@moflon.com

MAPH300F

3 Passages Fluid Electrical Slip Ring

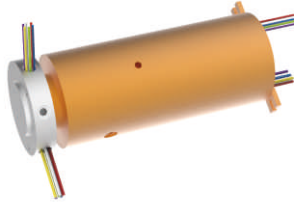

MAPH300F is 3 passages Pneumatic /Hydraulic + 2~96rings Electrical Slip Ring.
 Connection size including: M5,G1/8", G1/4", G3/8",G1/2" and bigger on request.
 Electrical rings including power wire, signal wire,Ethernet, USB, Industrial BUS, control Net, and all kinds of sensitive signal, etc. Normally use flange for installation, hollow shaft intallation on request.
 Media Types: Air/Gas,hydrogen,Nitrogen,Chemical, Water,Oil,etc.

Part# Explanation

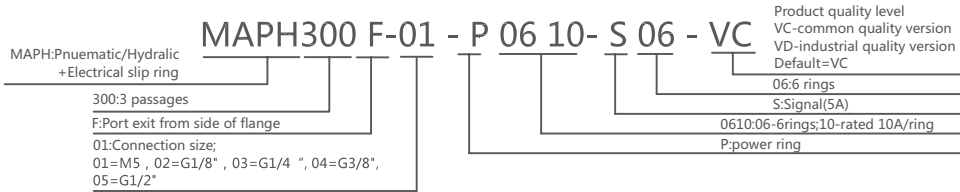

3 passages , M5 MAPH300F-01 Dimensions

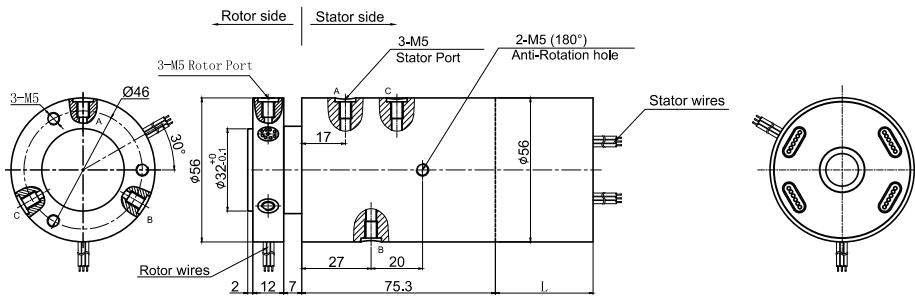

3 passages , G1/8 MAPH300F-02 Dimensions

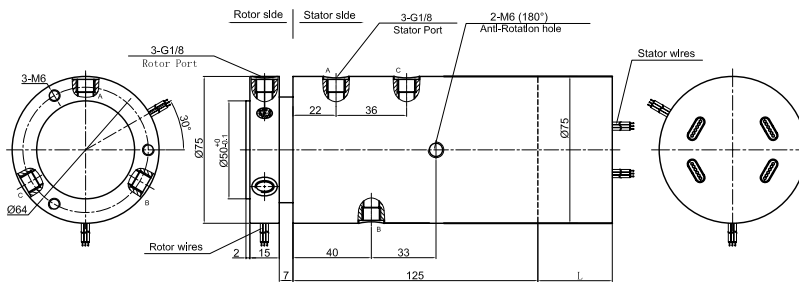

3 passages , G1/4 MAPH300F-03 Dimensions

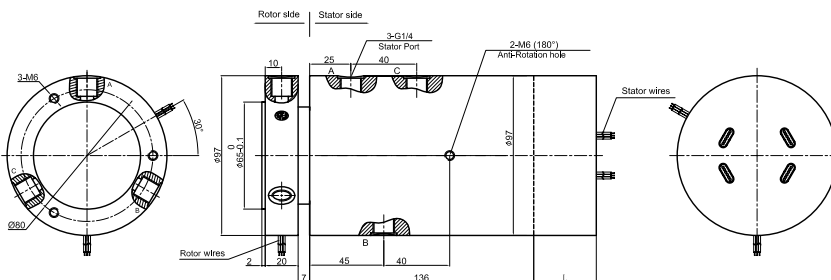

3 passages , G3/8 MAPH300F-04 Dimensions

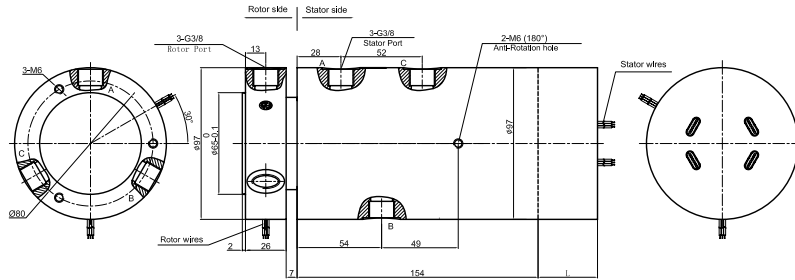

3 passages , G1/2 APH300F-05 Dimensions

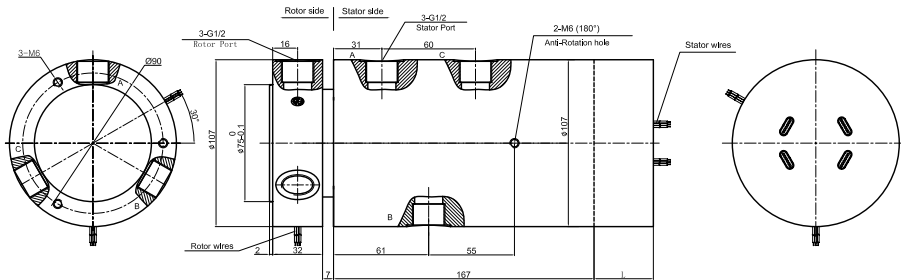

Specifications

Rotary Union Specification		
Parameter	Value	
Passage	2 passages	
Max .Pressure	10MPa , Vacuum 0.01torr	
Torque	depend on conection size	
Electrical Data		
Parameter	Value	
	Power	Signal
Rated Voltage	0~440VAC/VDC	0~440VAC/VDC
Insulation Resistance	≥1000MΩ/500VDC	≥1000MΩ/500VDC
Lead Wires	AWG17#Teflon	AWG22#Teflon
Lead Length	standard 300mm(adjustable)	
Insulation Strength	500VAC@50Hz , 60s	
Electrical Noise	<0.01Ω	
Mechanical Data		
Parameter	Value	
Working Life	See Product Quality Level Table	
Rotating Speed	See Product Quality Level Table	
Working Temperature	-30°C~80°C	
Operating Humidity	0~85% RH	
Contact Material	Precious Metal	
Housing Material	Aluminium Alloy	
Protection Grade	IP51	

Part# List

MAPH300F-XX Pneumatic/Hydraulic Slip Ring									
1) XX=01,connection size=M5 Pipe size3~6mm 2) XX=02connection size=G1/8" Pipe size3~10mm									
3) XX=03,connection size=G1/4" Pipe size3~12mm 4) XX=04,connection size=G3/8" Pipe size3~16mm									
5) XX=05,connection size=G1/2" Pipe size3~20mm									
Part#	Pneumatic/Hydraulic Passage	10A	Signal or 5A	Length (mm)	Part#	Pneumatic/Hydraulic Passage	10A	Signal or 5A	Length (mm)
MAPH300F-XX-S06	3 passages	0	6	38	MAPH300F-XX-P1210-S06	3 passages	12	6	71.6
MAPH300F-XX-P0210-S04	3 passages	2	4	38	MAPH300F-XX-P1410-S04	3 passages	14	4	71.6
MAPH300F-XX-P0410-S02	3 passages	4	2	38	MAPH300F-XX-P1610-S02	3 passages	16	2	71.6
MAPH300F-XX-P0610	3 passages	6	0	38	MAPH300F-XX-S24	3 passages	0	24	88.4
MAPH300F-XX-S12	3 passages	12	0	54.8	MAPH300F-XX-P0410-S20	3 passages	4	20	88.4
MAPH300F-XX-P0210-S10	3 passages	2	10	54.8	MAPH300F-XX-P0610-S18	3 passages	6	18	88.4
MAPH300F-XX-P0310-S09	3 passages	3	9	54.8	MAPH300F-XX-P1210-S12	3 passages	12	12	88.4
MAPH300F-XX-P0610-S06	3 passages	6	6	54.8	MAPH300F-XX-S30	3 passages	0	30	105.2
MAPH300F-XX-P0810-S04	3 passages	8	4	54.8	MAPH300F-XX-P0610-S24	3 passages	6	24	105.2
MAPH300F-XX-P1010-S02	3 passages	10	2	54.8	MAPH300F-XX-S36	3 passages	0	36	125
MAPH300F-XX-P1210	3 passages	12	0	54.8	MAPH300F-XX-S42	3 passages	0	42	141.8
MAPH300F-XX-S18	3 passages	0	18	71.6	MAPH300F-XX-S48	3 passages	0	48	158.6
MAPH300F-XX-P0210-S16	3 passages	2	16	71.6					
MAPH300F-XX-P0410-S14	3 passages	4	14	71.6					
MAPH300F-XX-P0610-S12	3 passages	6	12	71.6					
MAPH300F-XX-P0810-S10	3 passages	8	10	71.6					
MAPH300F-XX-P1010-S08	3 passages	10	8	71.6					

Note:N channels 10A rings parallel can be used as 1 channel N*10A current. For example: 2 rings 10A parallel could be used as 1 wires 20A.
10A and Signal(5A) can be combine in any way as you need.Max.ring:96 rings,can be customized based on standard slip rings.Please contact us.

Product Quality Level Table

Products Level Code	Max Rotating Speed	Working Life	Sealing Element
VC	100RPM	10 Million Revs	Common Seals
VD	300RPM	30 Million Revs	High-Quality Seals

Lead Wires Color Code

Ring	1	2	3	4	5	6	7	8	9	10	11	12
Color	BLK	RED	YLW	GRN	BLU	WHT	BLK	RED	YLW	GRN	BLU	WHT

(6 wires for 1 group color, from 7-12, repeat the same color as 1...6, indicated with number code pipe)

Options for custom slip ring

Note: Below special demands can be customized. According, the delivery date will be extended 3 to 15 days; also the cost will be increased 30% to 50%. Most of our basic parts are standard and modular, which can save the cost and lead time.

- ① Cable exit way and cable length can be customized for both rotor and stator.
- ② Because of the structure limitation, length/height/OD can be customized on your request.
- ③ Support current or signal up to 200 rings.
- ④ Aviation plug, terminal and heat-shrink tube are optional.
- ⑤ Hybrid slip ring for Yaskawa/Panasonic/Siemens servo control signal, power line and encoder line.
- ⑥ Support mixed high speed data transmission (including Ethernet, USB, RS232, RS485, Profibus, CanBUS, CANOPEN, DeviceNET, CC-LINK, ProfiNET, EtherCAT, etc.)
- ⑦ Can combine temperature control signal with thermocouple signal.
- ⑧ Special environment can be customized, such as quakeproof, high temperature, etc.
- ⑨ Hybrid Pneumatic/hydraulic and electric slip ring can be mixed.
- ⑩ High temperature can up to 500 degrees.
- ⑪ High pressure can up to 110KV
- ⑫ Rotating speed can up to 10000RPM
- ⑬ Maximum current can up to 5000 amperes.
- ⑭ Military grade
- ⑮ Optional for underwater IP65, IP68.
- ⑯ Optional for stainless steel housing

Technical support: technical@moflon.com

MAPH300S

3 Passages Fluid Electricity Slip Ring



MAPH300S is 3 passages Pneumatic /Hydraulic + 2~96rings Electrical Slip Ring.
 Connection size including: M5,G1/8", G1/4", G3/8",G1/2" and bigger on request.
 Electrical rings including power wire, signal wire,Ethernet, USB, Industrial BUS, control Net, and all kinds of sensitive signal, etc. Normally use flange for installation, hollow shaft intallation on request.
 Media Types: Air/Gas,hydrogen,Nitrogen,Chemical, Water,Oil,etc.

Part# Explanation

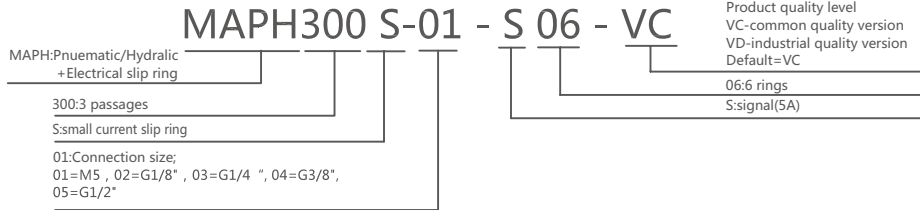

3 passages, M5 MAPH300S-01 Dimensions

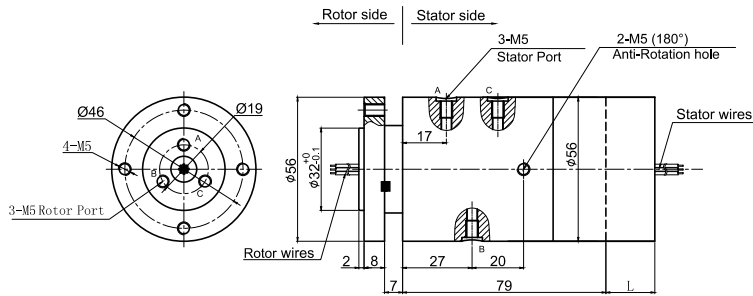

3 passages , G1/8 MAPH300S-02 Dimensions

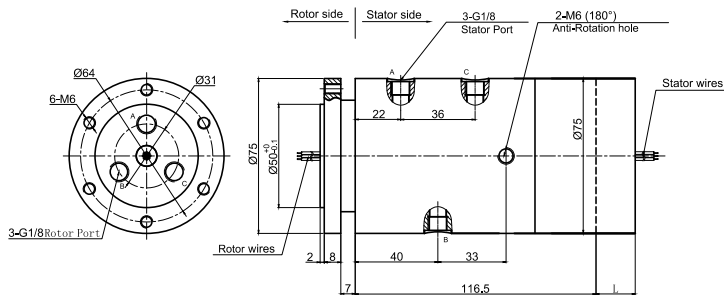

3 passages , G1/4 MAPH300S-03 Dimensions

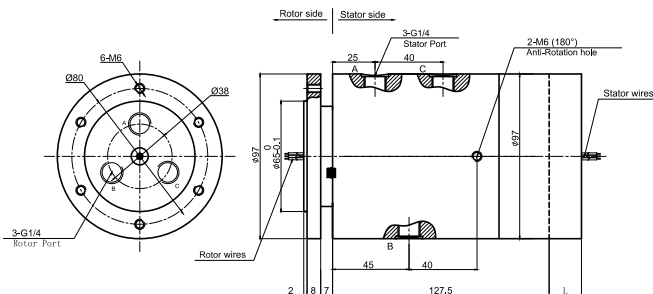

3 passages , G3/8 MAPH300S-04 Dimensions

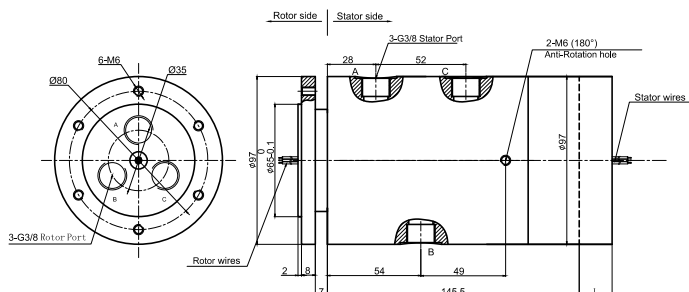

3 passages , G3/8 MAPH300S-05 Dimensions

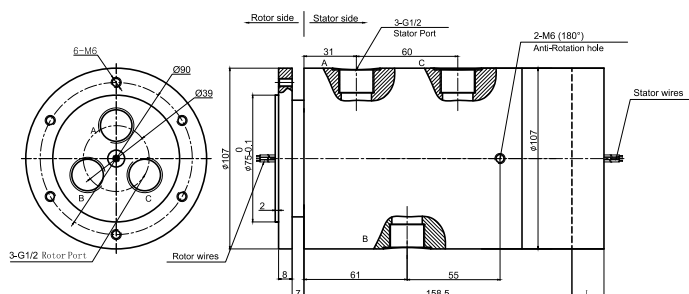

Specifications

Rotary Union Specification		
Parameter	Value	
Passage	3 passages	
Max .Pressure	10MPa , Vacuum 0.01torr	
Torque	depend on conection size	
Electrical Data		
Parameter	Value	
	Power	Signal
Rated Voltage	0~240VAC/VDC	0~240VAC/VDC
Insulation Resistance	≥1000MΩ/500VDC	≥1000MΩ/500VDC
Lead Wires	AWG28#Teflon	AWG28#Teflon
Lead Length	standard 300mm(adjustable)	
Insulation Strength	500VAC@50Hz , 60s	
Electrical Noise	<0.01Ω	
Mechanical Data		
Parameter	Value	
Working Life	See Product Quality Level Table	
Rotating Speed	See Product Quality Level Table	
Working Temperature	-30°C~80°C	
Operating Humidity	0~85% RH	
Contact Material	Precious Metal	
Housing Material	Aluminium Alloy	
Protection Grade	IP51	

Part# List

MAPH300S-XX Pneumatic/Hydraulic Slip Ring				
1) XX=01,connection size=M5 , Pipe size3~6mm 2) XX=02,connection size=G1/8 , Pipe size3~10mm				
3) XX=03,connection size=G1/4 , Pipe size3~12mm 4) XX=04,connection size=G3/8 , Pipe size3~16mm				
5) XX=05,connection size=G1/2 , Pipe size3~20mm				
Part#	Pneumatic/Hydraulic Passage	10A	Signal or 2A	Length (mm)
MAPH300S-XX-S06	3 passages	0	6	19
MAPH300S-XX-S12	3 passages	0	12	26
MAPH300S-XX-S18	3 passages	0	18	33
MAPH300S-XX-S24	3 passages	0	24	43.6
MAPH300S-XX-S36	3 passages	0	36	57.3
MAPH300S-XX-S56	3 passages	0	56	85.7

Note:N channels 10A rings parallel can be used as 1 channel N*10A current. For example: 2 rings 10A parallel could be used as 1 wires 20A 10A and Signal(5A) can be combine in any way as you need.Max.ring:96 rings,can be customized based on standard slip rings.Please contact us.

Product Quality Level Table

Products Level Code	Max Rotating Speed	Working Life	Sealing Element
VC	100RPM	10 Million Revs	Common Seals
VD	300RPM	30 Million Revs	High-Quality Seals

Lead Wires Color Code

Ring	1	2	3	4	5	6	7	8	9	10	11	12
Color	RED	GRN	YLW	VLT	GRY	BLK	BLU	DK BL	BN	OG	WHT	OCH

(6 wires for 1 group color, from 7-12, repeat the same color as 1...6, indicated with number code pipe)

Options for custom slip ring

Note: Below special demands can be customized. According, the delivery date will be extended 3 to 15 days; also the cost will be increased 30% to 50%. Most of our basic parts are standard and modular, which can save the cost and lead time.

- ① Cable exit way and cable length can be customized for both rotor and stator.
- ② Because of the structure limitation, length/height/OD can be customized on your request.
- ③ Support current or signal up to 200 rings.
- ④ Aviation plug, terminal and heat-shrink tube are optional.
- ⑤ Hybrid slip ring for Yaskawa/Panasonic/Siemens servo control signal, power line and encoder line.
- ⑥ Support mixed high speed data transmission (including Ethernet, USB, RS232, RS485, Profibus, CanBUS, CANOPEN, DeviceNET, CC-LINK, ProfiNET, EtherCAT, etc.)
- ⑦ Can combine temperature control signal with thermocouple signal.
- ⑧ Special environment can be customized, such as quakeproof, high temperature, etc.
- ⑨ Hybrid Pneumatic/hydraulic and electric slip ring can be mixed.
- ⑩ High temperature can up to 500 degrees.
- ⑪ High pressure can up to 110KV
- ⑫ Rotating speed can up to 10000RPM
- ⑬ Maximum current can up to 5000 amperes.
- ⑭ Military grade
- ⑮ Optional for underwater IP65, IP68.
- ⑯ Optional for stainless steel housing

Technical support: technical@moflon.com

MAPH400

4 Passages Fluid Electrical Slip Ring



MAPH400 is 4 passages Pneumatic /Hydraulic + 2~96rings Electrical Slip Ring.
 Connection size including: M5,G1/8", G1/4", G3/8",G1/2" and bigger on request.
 Electrical rings including power wire, signal wire,Ethernet, USB, Industrial BUS, control Net, and all kinds of sensitive signal, etc. Normally use flange for installation, hollow shaft intallation on request.
 Media Types: Air/Gas,hydrogen,Nitrogen,Chemical, Water,Oil,etc.

Part# Explanation

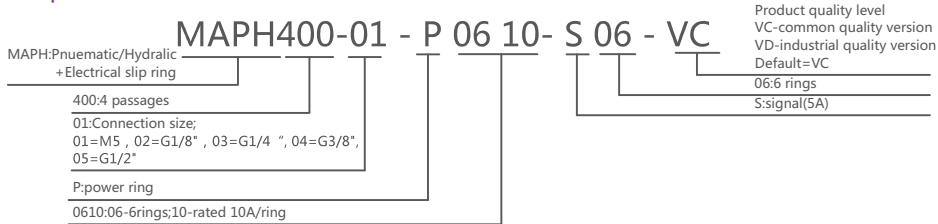

4 passages , M5 MAPH400-01 Dimensions

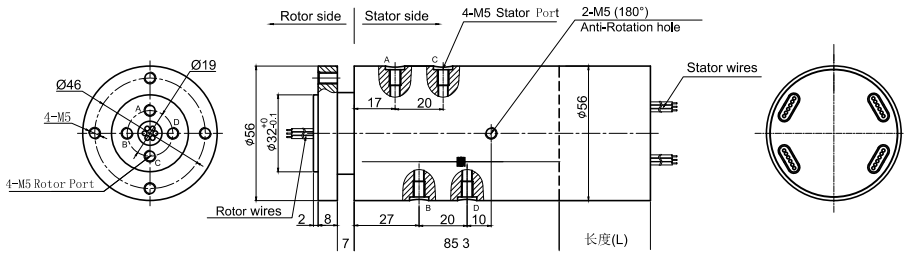

4 passages , G1/8 MAPH400-02 Dimensions

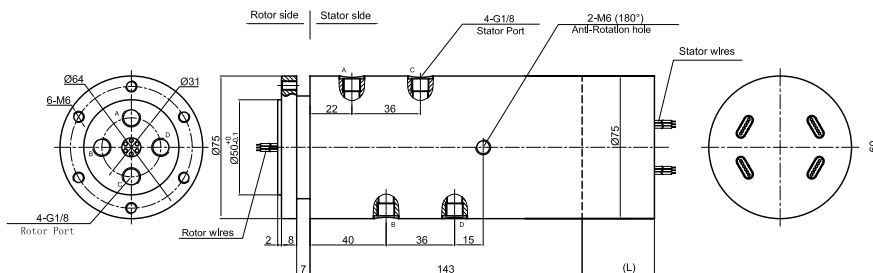

4 passages , G1/4 MAPH400-03 Dimensions

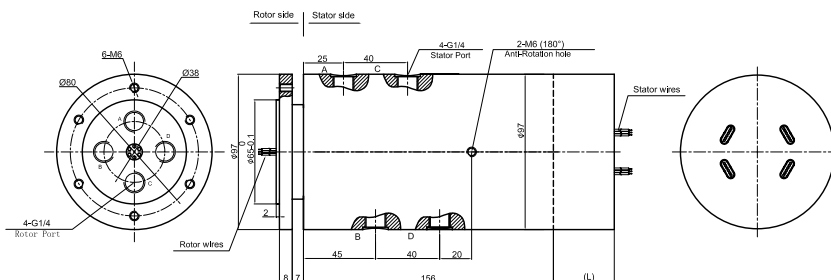

4 passages , G3/8 MAPH400-04 Dimensions

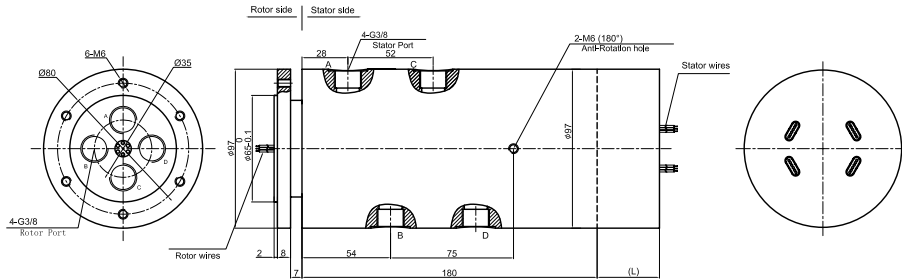

4 passages , G1/2 MAPH400-05 Dimensions

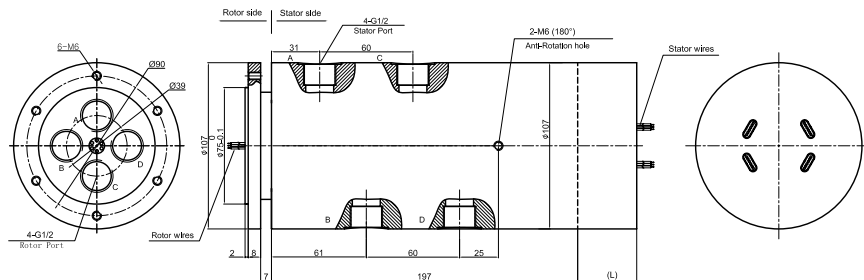

Specifications

Rotary Union Specification		
Parameter	Value	
Passage	2 passages	
Max .Pressure	10MPa , Vacuum 0.01torr	
Torque	depend on conection size	
Electrical Data		
Parameter	Value	
	Power	Signal
Rated Voltage	0~440VAC/VDC	0~440VAC/VDC
Insulation Resistance	≥1000MΩ/500VDC	≥1000MΩ/500VDC
Lead Wires	AWG17#Teflon	AWG22#Teflon
Lead Length	standard 300mm(adjustable)	
Insulation Strength	500VAC@50Hz , 60s	
Electrical Noise	<0.01Ω	
Mechanical Data		
Parameter	Value	
Working Life	See Product Quality Level Table	
Rotating Speed	See Product Quality Level Table	
Working Temperature	-30°C~80°C	
Operating Humidity	0~85% RH	
Contact Material	Precious Metal	
Housing Material	Aluminium Alloy	
Protection Grade	IP51	

Part# List

MAPH400-XX Pneumatic/Hydraulic Slip Ring									
1) XX=01,connection size=M5" Pipe size3~6mm 2) XX=02connection size=G1/8" Pipe size3~10mm									
3) XX=03,connection size=G1/4" Pipe size3~12mm 4) XX=04,connection size=G3/8" Pipe size3~16mm									
5) XX=05,connection size=G1/2" Pipe size3~20mm									
Part#	Pneumatic/Hydraulic Passage	10A	Signal or 5A	Length (mm)	Part#	Pneumatic/Hydraulic Passage	10A	Signal or 5A	Length (mm)
MAPH400-XX-S06	4 passages	0	6	38	MAPH400-XX-P1210-S06	4 passages	12	6	71.6
MAPH400-XX-P0210-S04	4 passages	2	4	38	MAPH400-XX-P1410-S04	4 passages	14	4	71.6
MAPH400-XX-P0410-S02	4 passages	4	2	38	MAPH400-XX-P1610-S02	4 passages	16	2	71.6
MAPH400-XX-P0610	4 passages	6	0	38	MAPH400-XX-S24	4 passages	0	24	88.4
MAPH400-XX-S12	4 passages	12	0	54.8	MAPH400-XX-P0410-S20	4 passages	4	20	88.4
MAPH400-XX-P0210-S10	4 passages	2	10	54.8	MAPH400-XX-P0610-S18	4 passages	6	18	88.4
MAPH400-XX-P0310-S09	4 passages	3	9	54.8	MAPH400-XX-P1210-S12	4 passages	12	12	88.4
MAPH400-XX-P0610-S06	4 passages	6	6	54.8	MAPH400-XX-S30	4 passages	0	30	105.2
MAPH400-XX-P0810-S04	4 passages	8	4	54.8	MAPH400-XX-P0610-S24	4 passages	6	24	105.2
MAPH400-XX-P1010-S02	4 passages	10	2	54.8	MAPH400-XX-S36	4 passages	0	36	125
MAPH400-XX-P1210	4 passages	12	0	54.8	MAPH400-XX-S42	4 passages	0	42	141.8
MAPH400-XX-S18	4 passages	0	18	71.6	MAPH400-XX-S48	4 passages	0	48	158.6
MAPH400-XX-P0210-S16	4 passages	2	16	71.6					
MAPH400-XX-P0410-S14	4 passages	4	14	71.6					
MAPH400-XX-P0610-S12	4 passages	6	12	71.6					
MAPH400-XX-P0810-S10	4 passages	8	10	71.6					
MAPH400-XX-P1010-S08	4 passages	10	8	71.6					

Note:N channels 10A rings parallel can be used as 1 channel N*10A current. For example: 2 rings 10A parallel could be used as 1 wires 20A.
10A and Signal(5A) can be combine in any way as you need.Max.ring:96 rings,can be customized based on standard slip rings.Please contact us.

Product Quality Level Table

Products Level Code	Max Rotating Speed	Working Life	Sealing Element
VC	100RPM	10 Million Revs	Common Seals
VD	300RPM	30 Million Revs	High-Quality Seals

Lead Wires Color Code

Ring	1	2	3	4	5	6	7	8	9	10	11	12
Color	BLK	RED	YLW	GRN	BLU	WHT	BLK	RED	YLW	GRN	BLU	WHT

(6 wires for 1 group color, from 7-12, repeat the same color as 1...6, indicated with number code pipe)

Options for custom slip ring

Note: Below special demands can be customized. According, the delivery date will be extended 3 to 15 days; also the cost will be increased 30% to 50%. Most of our basic parts are standard and modular, which can save the cost and lead time.

- ① Cable exit way and cable length can be customized for both rotor and stator.
- ② Because of the structure limitation, length/height/OD can be customized on your request.
- ③ Support current or signal up to 200 rings.
- ④ Aviation plug, terminal and heat-shrink tube are optional.
- ⑤ Hybrid slip ring for Yaskawa/Panasonic/Siemens servo control signal, power line and encoder line.
- ⑥ Support mixed high speed data transmission (including Ethernet, USB, RS232, RS485, Profibus, CanBUS, CANOPEN, DeviceNET, CC-LINK, ProfiNET, EtherCAT, etc.)
- ⑦ Can combine temperature control signal with thermocouple signal.
- ⑧ Special environment can be customized, such as quakeproof, high temperature, etc.
- ⑨ Hybrid Pneumatic/hydraulic and electric slip ring can be mixed.
- ⑩ High temperature can up to 500 degrees.
- ⑪ High pressure can up to 110KV
- ⑫ Rotating speed can up to 10000RPM
- ⑬ Maximum current can up to 5000 amperes.
- ⑭ Military grade
- ⑮ Optional for underwater IP65, IP68.
- ⑯ Optional for stainless steel housing

Technical support: technical@moflon.com

MAPH400F

4 Passages Fluid Electrical Slip Ring



MAPH400F is 4 passages Pneumatic /Hydraulic + 2~96rings Electrical Slip Ring.
 Connection size including: M5,G1/8", G1/4", G3/8",G1/2" and bigger on request.
 Electrical rings including power wire, signal wire,Ethernet, USB, Industrial BUS, control Net, and all kinds of sensitive signal, etc. Normally use flange for installation, hollow shaft intallation on request.
 Media Types: Air/Gas,hydrogen,Nitrogen,Chemical, Water,Oil,etc.

Part# Explanation

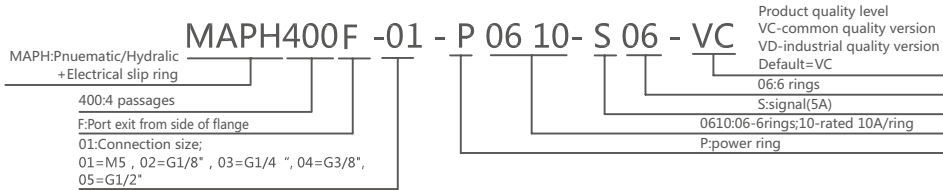

4 passages , M5 MAPH400F-01 Dimensions

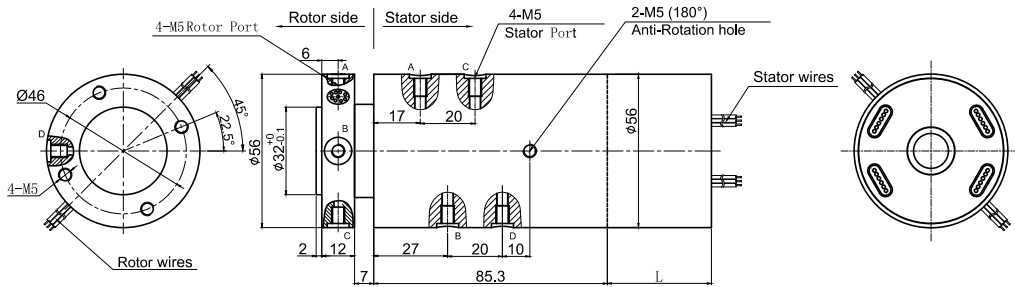

4 passages , G1/8 MAPH400F-02 Dimensions

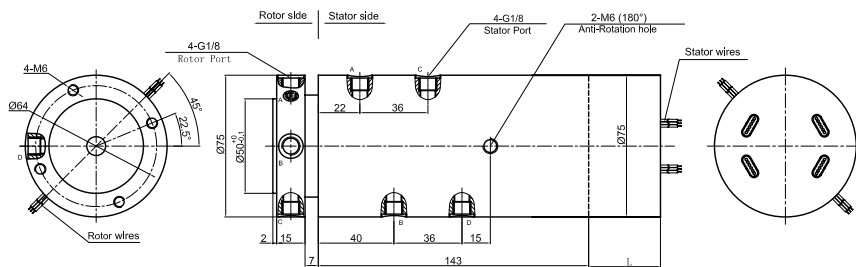

4 passages , G1/4 MAPH400F-03 Dimensions

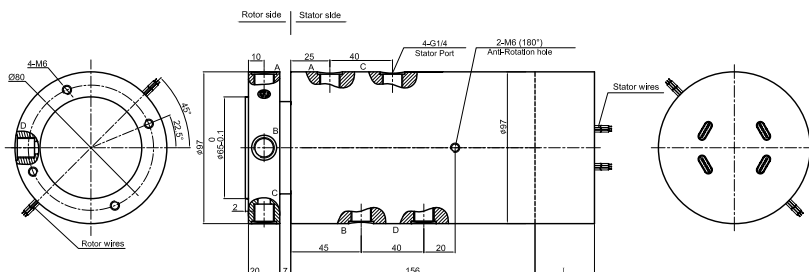

4 passages , G3/8 MAPH400F-04 Dimensions

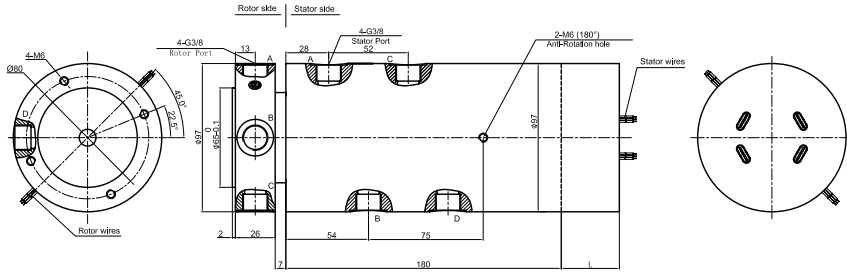

4 passages , G1/2 MAPH400F-05 Dimensions

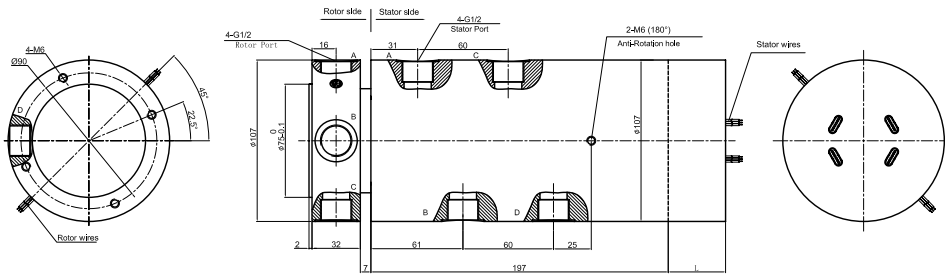

Specifications

Rotary Union Specification		
Parameter	Value	
Passage	4 passages	
Max .Pressure	10MPa , Vacuum 0.01torr	
Torque	depend on conection size	
Electrical Data		
Parameter	Value	
	Power	Signal
Rated Voltage	0~440VAC/VDC	0~440VAC/VDC
Insulation Resistance	≥1000MΩ/500VDC	≥1000MΩ/500VDC
Lead Wires	AWG17#Teflon	AWG22#Teflon
Lead Length	standard 300mm(adjustable)	
Insulation Strength	500VAC@50Hz , 60s	
Electrical Noise	<0.01Ω	
Mechanical Data		
Parameter	Value	
Working Life	See Product Quality Level Table	
Rotating Speed	See Product Quality Level Table	
Working Temperature	-30°C~80°C	
Operating Humidity	0~85% RH	
Contact Material	Precious Metal	
Housing Material	Aluminium Alloy	
Protection Grade	IP51	

Part# List

MAPH400F-XX Pneumatic/Hydraulic Slip Ring
 1) XX=01,connection size=M5" Pipe size3~6mm 2) XX=02,connection size=G1/8" Pipe size3~10mm
 3) XX=03,connection size=G1/4" Pipe size3~12mm 4) XX=04,connection size=G3/8" Pipe size3~16mm
 5) XX=05,connection size=G1/2" Pipe size3~20mm

Part#	Pneumatic/Hydraulic Passage	10A	Signal or 5A	Length (mm)	Part#	Pneumatic/Hydraulic Passage	10A	Signal or 5A	Length (mm)
MAPH400F-XX-S06	4 passages	0	6	38	MAPH400F-XX-P1210-S06	4 passages	12	6	71.6
MAPH400F-XX-P0210-S04	4 passages	2	4	38	MAPH400F-XX-P1410-S04	4 passages	14	4	71.6
MAPH400F-XX-P0410-S02	4 passages	4	2	38	MAPH400F-XX-P1610-S02	4 passages	16	2	71.6
MAPH400F-XX-P0610	4 passages	6	0	38	MAPH400F-XX-S24	4 passages	0	24	88.4
MAPH400F-XX-S12	4 passages	12	0	54.8	MAPH400F-XX-P0410-S20	4 passages	4	20	88.4
MAPH400F-XX-P0210-S10	4 passages	2	10	54.8	MAPH400F-XX-P0610-S18	4 passages	6	18	88.4
MAPH400F-XX-P0310-S09	4 passages	3	9	54.8	MAPH400F-XX-P1210-S12	4 passages	12	12	88.4
MAPH400F-XX-P0610-S06	4 passages	6	6	54.8	MAPH400F-XX-S30	4 passages	0	30	105.2
MAPH400F-XX-P0810-S04	4 passages	8	4	54.8	MAPH400F-XX-P0610-S24	4 passages	6	24	105.2
MAPH400F-XX-P1010-S02	4 passages	10	2	54.8	MAPH400F-XX-S36	4 passages	0	36	125
MAPH400F-XX-P1210	4 passages	12	0	54.8	MAPH400F-XX-S42	4 passages	0	42	141.8
MAPH400F-XX-S18	4 passages	0	18	71.6	MAPH400F-XX-S48	4 passages	0	48	158.6
MAPH400F-XX-P0210-S16	4 passages	2	16	71.6					
MAPH400F-XX-P0410-S14	4 passages	4	14	71.6					
MAPH400F-XX-P0610-S12	4 passages	6	12	71.6					
MAPH400F-XX-P0810-S10	4 passages	8	10	71.6					
MAPH400F-XX-P1010-S08	4 passages	10	8	71.6					

Note:N channels 10A rings parallel can be used as 1 channel N*10A current. For example: 2 rings 10A parallel could be used as 1 wires 20A.
 10A and Signal(5A) can be combine in any way as you need.Max.ring:96 rings,can be customized based on standard slip rings.Please contact us.

Product Quality Level Table

Products Level Code	Max Rotating Speed	Working Life	Sealing Element
VC	100RPM	10 Million Revs	Common Seals
VD	300RPM	30 Million Revs	High-Quality Seals

Lead Wires Color Code

Ring	1	2	3	4	5	6	7	8	9	10	11	12
Color	BLK	RED	YLW	GRN	BLU	WHT	BLK	RED	YLW	GRN	BLU	WHT

(6 wires for 1 group color, from 7-12, repeat the same color as 1...6, indicated with number code pipe)

Options for custom slip ring

Note: Below special demands can be customized. According, the delivery date will be extended 3 to 15 days; also the cost will be increased 30% to 50%. Most of our basic parts are standard and modular, which can save the cost and lead time.

- ① Cable exit way and cable length can be customized for both rotor and stator.
- ② Because of the structure limitation, length/height/OD can be customized on your request.
- ③ Support current or signal up to 200 rings.
- ④ Aviation plug, terminal and heat-shrink tube are optional.
- ⑤ Hybrid slip ring for Yaskawa/Panasonic/Siemens servo control signal, power line and encoder line.
- ⑥ Support mixed high speed data transmission (including Ethernet, USB, RS232, RS485, Profibus, CanBUS, CANOPEN, DeviceNET, CC-LINK, ProfiNET, EtherCAT, etc.)
- ⑦ Can combine temperature control signal with thermocouple signal.
- ⑧ Special environment can be customized, such as quakeproof, high temperature, etc.
- ⑨ Hybrid Pneumatic/hydraulic and electric slip ring can be mixed.
- ⑩ High temperature can up to 500 degrees.
- ⑪ High pressure can up to 110KV
- ⑫ Rotating speed can up to 10000RPM
- ⑬ Maximum current can up to 5000 amperes.
- ⑭ Military grade
- ⑮ Optional for underwater IP65, IP68.
- ⑯ Optional for stainless steel housing

Technical support: technical@moflon.com

MAPH400W

Double Flange Shaft ,4 Passages Fluid Electrical Slip Ring



MAPH400W is 4 passages Pneumatic /Hydraulic + 2~96rings Electrical Slip Ring.
 Connection size including: M5,G1/8", G1/4", G3/8",G1/2" and bigger on request.
 Electrical rings including power wire, signal wire,Ethernet, USB, Industrial BUS, control Net, and all kinds of sensitive signal, etc. Normally use flange for installation, hollow shaft intallation on request.
 Media Types: Air/Gas,hydrogen,Nitrogen,Chemical, Water,Oil,etc.

Part# Explanation

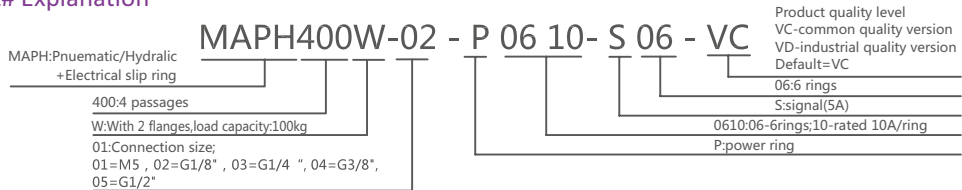

4 passages , G1/8

MAPH400W-02 Dimensions

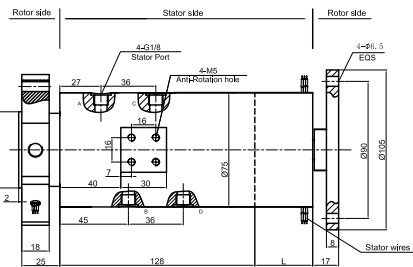
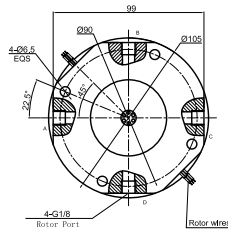

4 passages , G1/4

MAPH400W-03 Dimensions

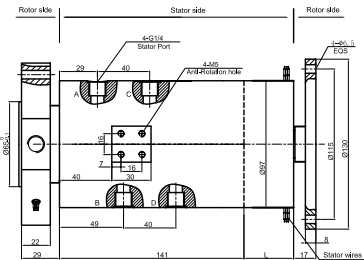
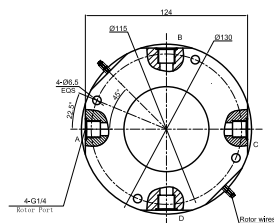

Specifications

Rotary Union Specifications			Mechanical Data	
Parameter	Value		Parameter	Value
Passage	4 passages		Working life	See Product Quality Level Table
Max Pressure	10MPa; Vacuum 0.01torr		Rotating Speed	See Product Quality Level Table
Torque	depend on conection size		Working Temperature	-30°C~80°C
Electrical Data			Operating Humidity	0~85% RH
Parameter	Value		Contact Material	Precious Metal
	Power	Signal	Housing Material	Aluminium Alloy
Rated Voltage	0~440VAC/VDC	0~440VAC/VDC	Protection Grade	IP51
Insulation Resistance	≥1000MΩ/500VDC			
Lead Wires	AWG17#Teflon	AWG22#Teflon		
Lead Length	standard 300mm(adjustable)			
Insulation Strength	500VAC@50Hz,60s			
Electrical Noise	<0.01Ω			

Part# List

MAPH400W-XX Pneumatic/Hydraulic Slip Ring
 1) XX=01,connection size=M5 Pipe size3~6mm 2) XX=02connection size=G1/8" Pipe size3~10mm
 3) XX=03,connection size=G1/4" Pipe size3~12mm 4) XX=04,connection size=G3/8" Pipe size3~16mm
 5) XX=05,connection size=G1/2 Pipe size3~20mm

Part#	Pneumatic/Hydraulic Passage	10A	Signal or 5A	Length (mm)	Part#	Pneumatic/Hydraulic Passage	10A	Signal or 5A	Length (mm)
MAPH400W-XX-S06	4 passages	0	6	38	MAPH400W-XX-P0810-S10	4 passages	8	10	71.6
MAPH400W-XX-P0210-S04	4 passages	2	4	38	MAPH400W-XX-P1010-S08	4 passages	10	8	71.6
MAPH400W-XX-P0410-S02	4 passages	4	2	38	MAPH400W-XX-P1210-S06	4 passages	12	6	71.6
MAPH400W-XX-P0610	4 passages	6	0	38	MAPH400W-XX-P1410-S04	4 passages	14	4	71.6
MAPH400W-XX-S12	4 passages	12	0	54.8	MAPH400W-XX-P1610-S02	4 passages	16	2	71.6
MAPH400W-XX-P0210-S10	4 passages	2	10	54.8	MAPH400W-XX-S24	4 passages	0	24	88.4
MAPH400W-XX-P0310-S09	4 passages	3	9	54.8	MAPH400W-XX-P0410-S20	4 passages	4	20	88.4
MAPH400W-XX-P0610-S06	4 passages	6	6	54.8	MAPH400W-XX-P0610-S18	4 passages	6	18	88.4
MAPH400W-XX-P0810-S04	4 passages	8	4	54.8	MAPH400W-XX-P1210-S12	4 passages	12	12	88.4
MAPH400W-XX-P1010-S02	4 passages	10	2	54.8	MAPH400W-XX-S30	4 passages	0	30	105.2
MAPH400W-XX-P1210	4 passages	12	0	54.8	MAPH400W-XX-P0610-S24	4 passages	6	24	105.2
MAPH400W-XX-S18	4 passages	0	18	71.6	MAPH400W-XX-S36	4 passages	0	36	125
MAPH400W-XX-P0210-S16	4 passages	2	16	71.6	MAPH400W-XX-S42	4 passages	0	42	141.8
MAPH400W-XX-P0410-S14	4 passages	4	14	71.6	MAPH400W-XX-S48	4 passages	0	48	158.6
MAPH400W-XX-P0610-S12	4 passages	6	12	71.6					

Note:N channels 10A rings parallel can be used as 1 channel N*10A current. For example: 2 rings 10A parallel could be used as 1 wires 20A.
 10A and Signal(5A) can be combine in any way as you need.Max.ring:96 rings,can be customized based on standard slip rings.Please contact us.

Product Quality Level Table

Products Level Code	Max Rotating Speed	Working Life	Sealing Element
VC	100RPM	10 Million Revs	Common Seals
VD	300RPM	30 Million Revs	High-Quality Seals

Lead Wires Color Code

Ring	1	2	3	4	5	6	7	8	9	10	11	12
Color	BLK	RED	YLW	GRN	BLU	WHT	BLK	RED	YLW	GRN	BLU	WHT

(6 wires for 1 group color, from 7-12, repeat the same color as 1...6, indicated with number code pipe)

Options for custom slip ring

Note: Below special demands can be customized. According, the delivery date will be extended 3 to 15 days; also the cost will be increased 30% to 50%. Most of our basic parts are standard and modular, which can save the cost and lead time.

- ① Cable exit way and cable length can be customized for both rotor and stator.
- ② Because of the structure limitation, length/height/OD can be customized on your request.
- ③ Support current or signal up to 200 rings.
- ④ Aviation plug, terminal and heat-shrink tube are optional.
- ⑤ Hybrid slip ring for Yaskawa/Panasonic/Siemens servo control signal, power line and encoder line.
- ⑥ Support mixed high speed data transmission (including Ethernet, USB, RS232, RS485, Profibus, CanBUS, CANOPEN, DeviceNET, CC-LINK, Profinet, EtherCAT, etc.)
- ⑦ Can combine temperature control signal with thermocouple signal.
- ⑧ Special environment can be customized, such as quakeproof, high temperature, etc.
- ⑨ Hybrid Pneumatic/hydraulic and electric slip ring can be mixed.
- ⑩ High temperature can up to 500 degrees.
- ⑪ High pressure can up to 110KV
- ⑫ Rotating speed can up to 10000RPM
- ⑬ Maximum current can up to 5000 amperes.
- ⑭ Military grade
- ⑮ Optional for underwater IP65, IP68.
- ⑯ Optional for stainless steel housing

Technical support: technical@moflon.com

MAPH400S

4 Passages Fluid Electrical Slip Ring



MAPH400S is 4 passages Pneumatic /Hydraulic + 2~96rings Electrical Slip Ring.
 Connection size including: M5,G1/8", G1/4", G3/8",G1/2" and bigger on request.
 Electrical rings including power wire, signal wire,Ethernet, USB, Industrial BUS, control Net, and all kinds of sensitive signal, etc. Normally use flange for installation, hollow shaft intallation on request.
 Media Types: Air/Gas,hydrogen,Nitrogen,Chemical, Water,Oil,etc.

Part# Explanation

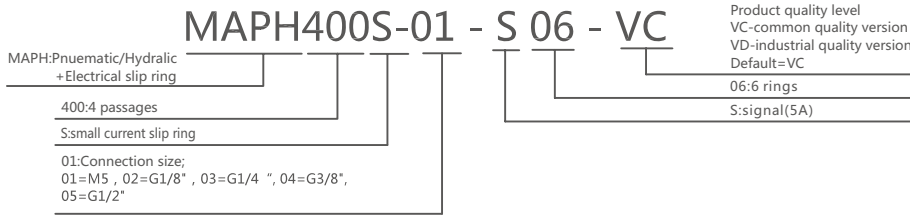

4 passages , M5 MAPH400S-01 Dimensions

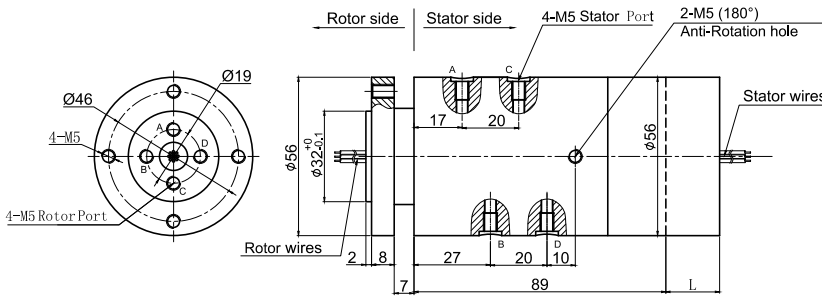

4 passages , G1/8 MAPH400S-02 Dimensions

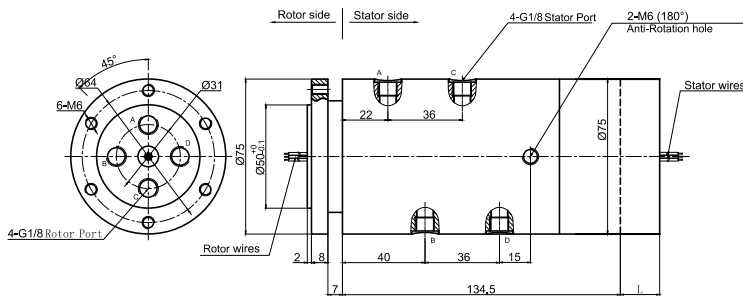

4 passages , G1/4 MAPH400S-03 Dimensions

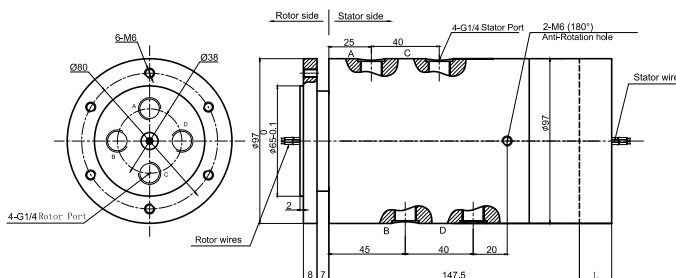

4 passages , G3/8 MAPH400S-04 Dimensions

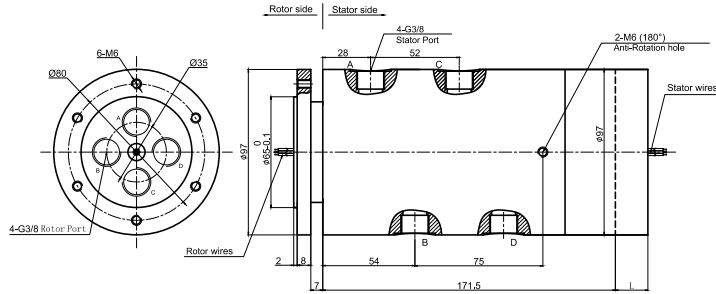

4 passages , G1/2 MAPH400S-05 Dimensions

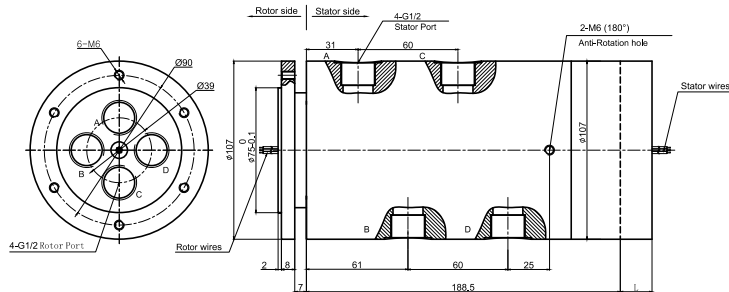

Specifications

Rotary Union Specification		
Parameter	Value	
Passage	2 passages	
Max .Pressure	10MPa , Vacuum 0.01torr	
Torque	depend on conection size	
Electrical Data		
Parameter	Value	
	Power	Signal
Rated Voltage	0~240VAC/VDC	0~240VAC/VDC
Insulation Resistance	≥1000MΩ/500VDC	≥1000MΩ/500VDC
Lead Wires	AWG28#Teflon	AWG28#Teflon
Lead Length	standard 300mm(adjustable)	
Insulation Strength	500VAC@50Hz , 60s	
Electrical Noise	<0.01Ω	
Mechanical Data		
Parameter	Value	
Working Life	See Product Quality Level Table	
Rotating Speed	See Product Quality Level Table	
Working Temperature	-30°C~80°C	
Operating Humidity	0~85% RH	
Contact Material	Precious Metal	
Housing Material	Aluminium Alloy	
Protection Grade	IP51	

Part# List

MAPH400S-XX Pneumatic/Hydraulic Slip Ring				
1) XX=01,connection size=M5 Pipe size3~6mm 2) XX=02,connection size=G1/8" Pipe size3~10mm				
3) XX=03,connection size=G1/4" Pipe size3~12mm 4) XX=04,connection size=G3/8" Pipe size3~16mm				
5) XX=05,connection size=G1/2" Pipe size3~20mm				
Part#	Pneumatic/Hydraulic Passage	10A	Signal or 2A	Length (mm)
MAPH400S-XX-S06	4 passages	0	6	19
MAPH400S-XX-S12	4 passages	0	12	26
MAPH400S-XX-S18	4 passages	0	18	33
MAPH400S-XX-S24	4 passages	0	24	43.6
MAPH400S-XX-S36	4 passages	0	36	57.3
MAPH400S-XX-S56	4 passages	0	56	85.7

Note:N channels 10A rings parallel can be used as 1 channel N*10A current. For example: 2 rings 10A parallel could be used as 1 wires 20A.
10A and Signal(5A) can be combine in any way as you need.Max.ring:96 rings,can be customized based on standard slip rings.Please contact us.

Product Quality Level Table

Products Level Code	Max Rotating Speed	Working Life	Sealing Element
VC	100RPM	10 Million Revs	Common Seals
VD	300RPM	30 Million Revs	High-Quality Seals

Lead Wires Color Code

Ring	1	2	3	4	5	6	7	8	9	10	11	12
Color	RED	GRN	YLW	VLT	GRY	BLK	BLU	DK BL	BN	OG	WHT	OCH

(6 wires for 1 group color, from 7-12, repeat the same color as 1...6, indicated with number code pipe)

Options for custom slip ring

Note: Below special demands can be customized. According, the delivery date will be extended 3 to 15 days; also the cost will be increased 30% to 50%. Most of our basic parts are standard and modular, which can save the cost and lead time.

- ① Cable exit way and cable length can be customized for both rotor and stator.
- ② Because of the structure limitation, length/height/OD can be customized on your request.
- ③ Support current or signal up to 200 rings.
- ④ Aviation plug, terminal and heat-shrink tube are optional.
- ⑤ Hybrid slip ring for Yaskawa/Panasonic/Siemens servo control signal, power line and encoder line.
- ⑥ Support mixed high speed data transmission (including Ethernet, USB, RS232, RS485, Profibus, CanBUS, CANOPEN, DeviceNET, CC-LINK, ProfiNET, EtherCAT, etc.)
- ⑦ Can combine temperature control signal with thermocouple signal.
- ⑧ Special environment can be customized, such as quakeproof, high temperature, etc.
- ⑨ Hybrid Pneumatic/hydraulic and electric slip ring can be mixed.
- ⑩ High temperature can up to 500 degrees.
- ⑪ High pressure can up to 110KV
- ⑫ Rotating speed can up to 10000RPM
- ⑬ Maximum current can up to 5000 amperes.
- ⑭ Military grade
- ⑮ Optional for underwater IP65, IP68.
- ⑯ Optional for stainless steel housing

Technical support: technical@moflon.com

MAPH600

6 Passages Fluid Electrical Slip Ring



MAPH600 is 6 passages Pneumatic /Hydraulic + 2~96rings Electrical Slip Ring.
 Connection size including: M5,G1/8", G1/4", G3/8",G1/2" and bigger on request.
 Electrical rings including power wire, signal wire,Ethernet, USB, Industrial BUS, control Net, and all kinds of sensitive signal, etc. Normally use flange for installation, hollow shaft intallation on request.
 Media Types: Air/Gas,hydrogen,Nitrogen,Chemical, Water,Oil,etc.

Part# Explanation

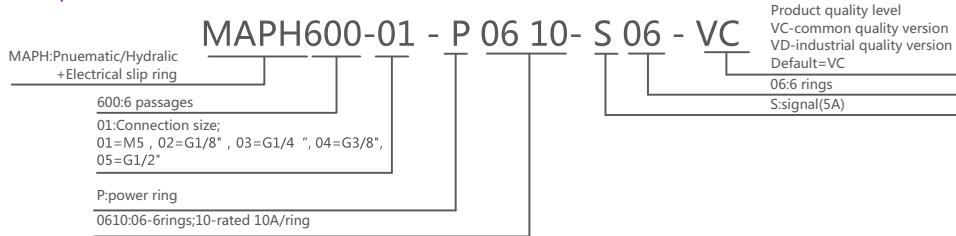

6 Passages , M5 MAPH600-01 Dimensions

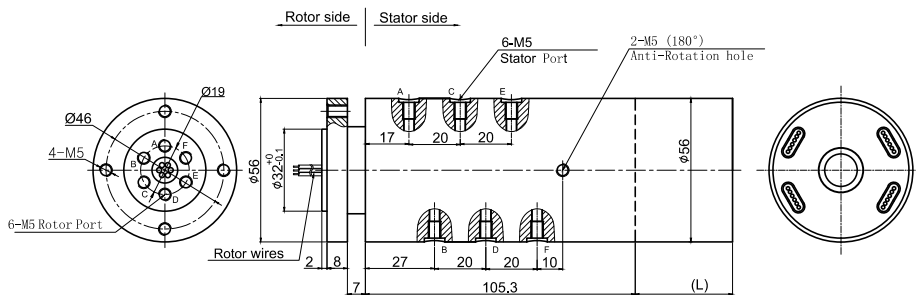

6 Passages , G1/8 MAPH600-02 Dimensions

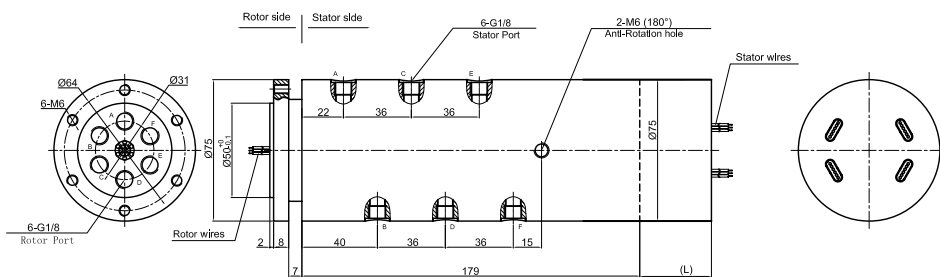

6 Passages , G1/4 MAPH600-03 Dimensions

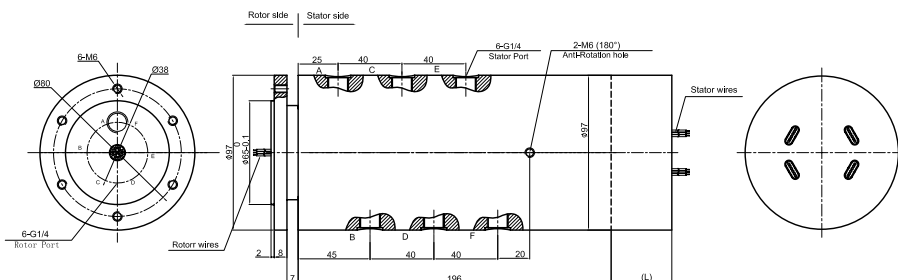

Specifications

Rotary Union Specifications			Mechanical Data	
Parameter	Value		Parameter	Value
Passage	6 passages		Working life	See Product Quality Level Table
Max Pressure	10MPa, Vacuum 0.01torr		Rotating Speed	See Product Quality Level Table
Torque	depend on connection size		Working Temperature	-30°C~80°C
Electrical Data			Operating Humidity	0~85% RH
Parameter	Value		Contact Material	Precious Metal
	Power	Signal	Housing Material	Aluminium Alloy
Rated Voltage	0~440VAC/VDC	0~440VAC/VDC	Protection Grade	IP51
Insulation Resistance	≥1000MΩ/500VDC	≥1000MΩ/500VDC		
Lead Wires	AWG17#Teflon	AWG22#Teflon		
Lead Length	standard 300mm(adjustable)			
Insulation Strength	500VAC@50Hz, 60s			
Electrical Noise	<0.01Ω			

Part# List

MAPH600-XX Pneumatic/Hydraulic Slip Ring
 1) XX=01,connection size=M5" Pipe size3~6mm
 2) XX=02connection size=G1/8" Pipe size3~10mm
 3) XX=03,connection size=G1/4" Pipe size3~12mm

Part#	Pneumatic/Hydraulic Passage	10A	Signal or 5A	Length (mm)	Part#	Pneumatic/Hydraulic Passage	10A	Signal or 5A	Length (mm)
MAPH600-XX-S06	6 passages	0	6	38	MAPH600-XX-P1210-S06	6 passages	12	6	71.6
MAPH600-XX-P0210-S04	6 passages	2	4	38	MAPH600-XX-P1410-S04	6 passages	14	4	71.6
MAPH600-XX-P0410-S02	6 passages	4	2	38	MAPH600-XX-P1610-S02	6 passages	16	2	71.6
MAPH600-XX-P0610	6 passages	6	0	38	MAPH600-XX-S24	6 passages	0	24	88.4
MAPH600-XX-S12	6 passages	12	0	54.8	MAPH600-XX-P0410-S20	6 passages	4	20	88.4
MAPH600-XX-P0210-S10	6 passages	2	10	54.8	MAPH600-XX-P0610-S18	6 passages	6	18	88.4
MAPH600-XX-P0310-S09	6 passages	3	9	54.8	MAPH600-XX-P1210-S12	6 passages	12	12	88.4
MAPH600-XX-P0610-S06	6 passages	6	6	54.8	MAPH600-XX-S30	6 passages	0	30	105.2
MAPH600-XX-P0810-S04	6 passages	8	4	54.8	MAPH600-XX-P0610-S24	6 passages	6	24	105.2
MAPH600-XX-P1010-S02	6 passages	10	2	54.8	MAPH600-XX-S36	6 passages	0	36	125
MAPH600-XX-P1210	6 passages	12	0	54.8	MAPH600-XX-S42	6 passages	0	42	141.8
MAPH600-XX-S18	6 passages	0	18	71.6	MAPH600-XX-S48	6 passages	0	48	158.6
MAPH600-XX-P0210-S16	6 passages	2	16	71.6					
MAPH600-XX-P0410-S14	6 passages	4	14	71.6					
MAPH600-XX-P0610-S12	6 passages	6	12	71.6					
MAPH600-XX-P0810-S10	6 passages	8	10	71.6					
MAPH600-XX-P1010-S08	6 passages	10	8	71.6					

Note:N channels 10A rings parallel can be used as 1 channel N*10A current. For example: 2 rings 10A parallel could be used as 1 wires 20A.
 10A and Signal(5A) can be combine in any way as you need.Max.ring:96 rings,can be customized based on standard slip rings.Please contact us.

Product Quality Level Table

Products Level Code	Max Rotating Speed	Working Life	Sealing Element
VC	100RPM	10 Million Revs	Common Seals
VD	300RPM	30 Million Revs	High-Quality Seals

Lead Wires Color Code

Ring	1	2	3	4	5	6	7	8	9	10	11	12
Color	BLK	RED	YLW	GRN	BLU	WHT	BLK	RED	YLW	GRN	BLU	WHT

(6 wires for 1 group color, from 7-12, repeat the same color as 1...6, indicated with number code pipe)

Options for custom slip ring

Note:Below special demands can be customized. According, the delivery date will be extended 3 to 15 days; also the cost will be increased 30% to 50%. Most of our basic parts are standard and modular, which can save the cost and lead time.

- ① Cable exit way and cable length can be customized for both rotor and stator.
- ② Because of the structure limitation, length/height/OD can be customized on your request.
- ③ Support current or signal up to 200 rings.
- ④ Aviation plug, terminal and heat-shrink tube are optional.
- ⑤ Hybrid slip ring for Yaskawa/Panasonic/Siemens servo control signal, power line and encoder line.
- ⑥ Support mixed high speed data transmission (including Ethernet, USB, RS232, RS485, Profibus, CanBUS, CANOPEN, DeviceNET, CC-LINK, ProfINET, EtherCAT, etc.)

- ⑦ Can combine temperature control signal with thermocouple signal.
 - ⑧ Special environment can be customized, such as quakeproof, high temperature, etc.
 - ⑨ Hybrid Pneumatic/hydraulic and electric slip ring can be mixed.
 - ⑩ High temperature can up to 500 degrees.
 - ⑪ High voltage can up to 110KV
 - ⑫ Rotating speed can up to 10000RPM
 - ⑬ Maximum current can up to 5000 amperes.
 - ⑭ Military grade
 - ⑮ Optional for underwater IP65, IP68.
 - ⑯ Optional for stainless steel housing
- Technical support : technical@moflon.com

MAPH600F

6 Passages Fluid Electrical Slip Ring

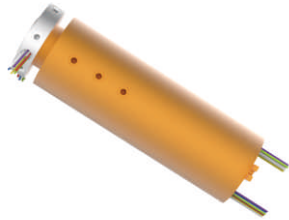

MAPH600F is 6 passages Pneumatic /Hydraulic + 2~96rings Electrical Slip Ring.
 Connection size including: M5,G1/8", G1/4", G3/8",G1/2" and bigger on request.
 Electrical rings including power wire, signal wire,Ethernet, USB, Industrial BUS, control Net, and all kinds of sensitive signal, etc. Normally use flange for installation, hollow shaft intallation on request.
 Media Types: Air/Gas,hydrogen,Nitrogen,Chemical, Water,Oil,etc.

Part# Explanation

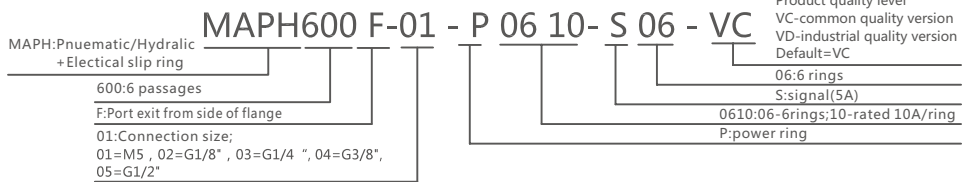

6 Passages , M5 MAPH600F-01 Dimensions

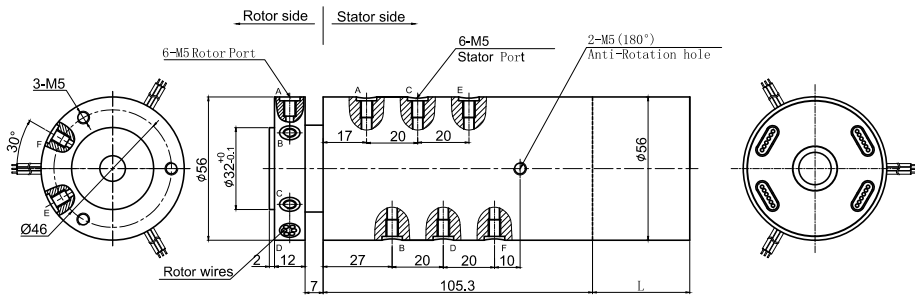

6 Passages , G1/8 MAPH600F-02 Dimensions

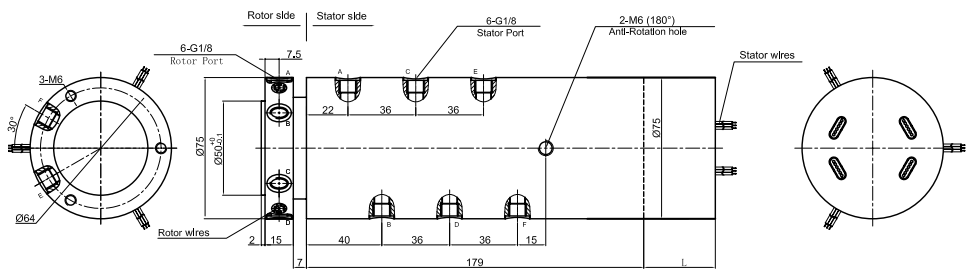

6 Passages , G1/8 MAPH600F-03 Dimensions

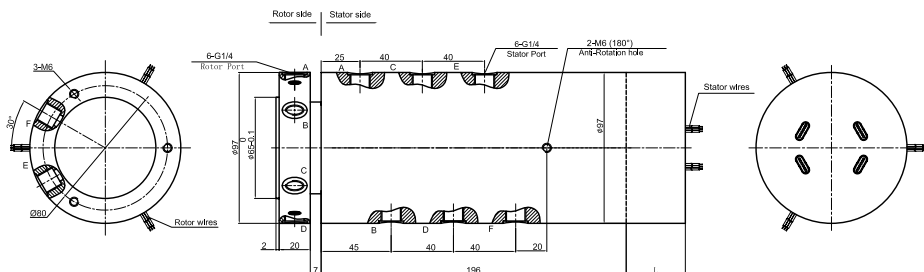

Specifications

Rotary Union Specifications			Mechanical Data	
Parameter	Value		Parameter	Value
Passage	6 passages		Working life	See Product Quality Level Table
Max Pressure	10MPa; Vacuum 0.01torr		Rotating Speed	See Product Quality Level Table
Torque	depend on connection size		Working Temperature	-30°C~80°C
Electrical Data			Operating Humidity	0~85% RH
Parameter	Value		Contact Material	Precious Metal
	Power	Signal	Housing Material	Aluminium Alloy
Rated Voltage	0~440VAC/VDC	0~440VAC/VDC	Protection Grade	IP51
Insulation Resistance	≥1000MΩ/500VDC			
Lead Wires	AWG17#Teflon	AWG22#Teflon		
Lead Length	standard 300mm(adjustable)			
Insulation Strength	500VAC@50Hz, 60s			
Electrical Noise	<0.01Ω			

Part# List

MAPH600F-XX Pneumatic/Hydraulic Slip Ring
 1) XX=01,connection size=M5 Pipe size3~6mm
 2) XX=02,connection size=G1/8" Pipe size3~10mm
 3) XX=03,connection size=G1/4" Pipe size3~12mm

Part#	Pneumatic/Hydraulic Passage	10A	Signal or 5A	Length (mm)	Part#	Pneumatic/Hydraulic Passage	10A	Signal or 5A	Length (mm)
MAPH600F-XX-S06	6 passages	0	6	38	MAPH600F-XX-P0810-S10	6 passages	8	10	71.6
MAPH600F-XX-P0210-S04	6 passages	2	4	38	MAPH600F-XX-P1010-S08	6 passages	10	8	71.6
MAPH600F-XX-P0410-S02	6 passages	4	2	38	MAPH600F-XX-P1210-S06	6 passages	12	6	71.6
MAPH600F-XX-P0610	6 passages	6	0	38	MAPH600F-XX-P1410-S04	6 passages	14	4	71.6
MAPH600F-XX-S12	6 passages	12	0	54.8	MAPH600F-XX-P1610-S02	6 passages	16	2	71.6
MAPH600F-XX-P0210-S10	6 passages	2	10	54.8	MAPH600F-XX-S24	6 passages	0	24	88.4
MAPH600F-XX-P0310-S09	6 passages	3	9	54.8	MAPH600F-XX-P0410-S20	6 passages	4	20	88.4
MAPH600F-XX-P0610-S06	6 passages	6	6	54.8	MAPH600F-XX-P0610-S18	6 passages	6	18	88.4
MAPH600F-XX-P0810-S04	6 passages	8	4	54.8	MAPH600F-XX-P1210-S12	6 passages	12	12	88.4
MAPH600F-XX-P1010-S02	6 passages	10	2	54.8	MAPH600F-XX-S30	6 passages	0	30	105.2
MAPH600F-XX-P1210	6 passages	12	0	54.8	MAPH600F-XX-P0610-S24	6 passages	6	24	105.2
MAPH600F-XX-S18	6 passages	0	18	71.6	MAPH600F-XX-S36	6 passages	0	36	125
MAPH600F-XX-P0210-S16	6 passages	2	16	71.6	MAPH600F-XX-S42	6 passages	0	42	141.8
MAPH600F-XX-P0410-S14	6 passages	4	14	71.6	MAPH600F-XX-S48	6 passages	0	48	158.6
MAPH600F-XX-P0610-S12	6 passages	6	12	71.6					

Note:N channels 10A rings parallel can be used as 1 channel N*10A current. For example: 2 rings 10A parallel could be used as 1 wires 20A.
 10A and Signal(5A) can be combine in any way as you need.Max.ring:96 rings,can be customized based on standard slip rings.Please contact us.

Product Quality Level Table

Products Level Code	Max Rotating Speed	Working Life	Sealing Element
VC	100RPM	10 Million Revs	Common Seals
VD	300RPM	30 Million Revs	High-Quality Seals

Lead Wires Color Code

Ring	1	2	3	4	5	6	7	8	9	10	11	12
Color	BLK	RED	YLW	GRN	BLU	WHT	BLK	RED	YLW	GRN	BLU	WHT

(6 wires for 1 group color, from 7-12, repeat the same color as 1...6, indicated with number code pipe)

Options for custom slip ring

Note : Below special demands can be customized. According, the delivery date will be extended 3 to 15 days; also the cost will be increased 30% to 50%. Most of our basic parts are standard and modular, which can save the cost and lead time.

- ① Cable exit way and cable length can be customized for both rotor and stator.
- ② Because of the structure limitation, length/height/OD can be customized on your request.
- ③ Support current or signal up to 200 rings.
- ④ Aviation plug, terminal and heat-shrink tube are optional.
- ⑤ Hybrid slip ring for Yaskawa/Panasonic/Siemens servo control signal, power line and encoder line.

- ⑦ Can combine temperature control signal with thermocouple signal.
 - ⑧ Special environment can be customized, such as quakeproof, high temperature, etc.
 - ⑨ Hybrid Pneumatic/hydraulic and electric slip ring can be mixed.
 - ⑩ High temperature can up to 500 degrees.
 - ⑪ High voltage can up to 110KV
 - ⑫ Rotating speed can up to 10000RPM
 - ⑬ Maximum current can up to 5000 amperes.
 - ⑭ Military grade
 - ⑮ Optional for underwater IP65, IP68.
 - ⑯ Optional for stainless steel housing
- Technical support : technical@moflon.com

MAPH600S

6 Passages Fluid Electrical Slip Ring



MAPH600S is 6 passages Pneumatic/Hydraulic + 2~96rings Electrical Slip Ring.
 Connection size including: M5,G1/8", G1/4", G3/8",G1/2" and bigger on request.
 Electrical rings including power wire, signal wire,Ethernet, USB, Industrial BUS, control Net, and all kinds of sensitive signal, etc. Normally use flange for installation, hollow shaft intallation on request.
 Media Types: Air/Gas,hydrogen,Nitrogen,Chemical, Water,Oil,etc.

Part# Explanation

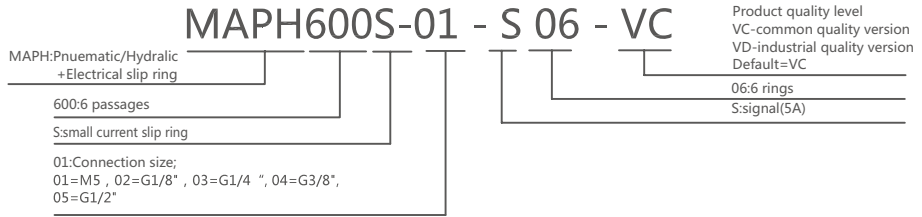

6 Passages , M5 MAPH600S-01 Dimensions

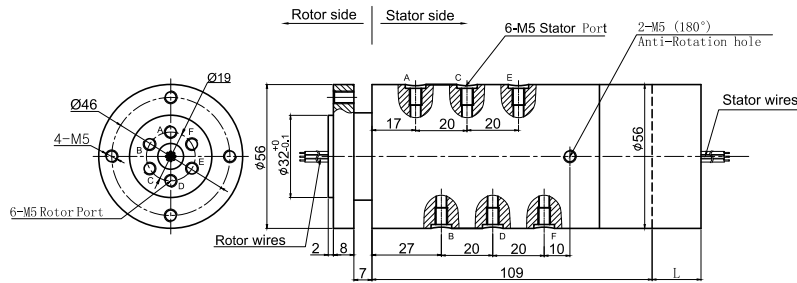

6 Passages , G1/8 MAPH600S-02 Dimensions

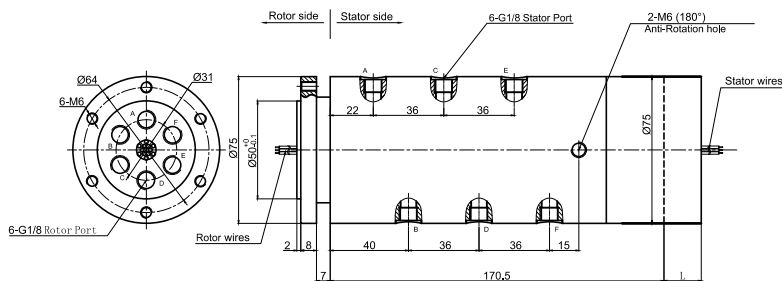

6 Passages , G1/4 MAPH600S-03 Dimensions

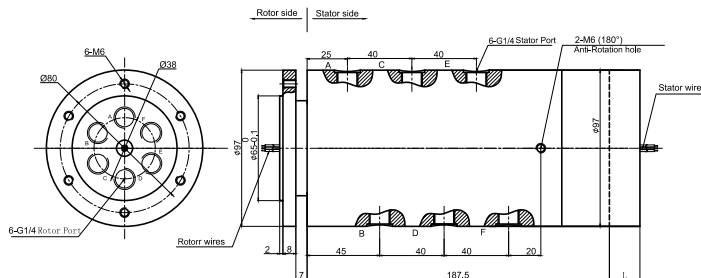

Specifications

Rotary Union Specifications			Mechanical Data	
Parameter	Value		Parameter	Value
Passage	6 passages		Working life	See Product Quality Level Table
Max Pressure	10MPa; Vacuum 0.01torr		Rotating Speed	See Product Quality Level Table
Torque	depend on connection size		Working Temperature	-30°C~80°C
Electrical Data			Operating Humidity	0~85% RH
Parameter	Value		Contact Material	Precious Metal
	Power	Signal	Housing Material	Aluminium Alloy
Rated Voltage	0~240VAC/VDC	0~240VAC/VDC	Protection Grade	IP51
Insulation Resistance	≥1000MΩ/500VDC	≥1000MΩ/500VDC		
Lead Wires	AWG28#Teflon	AWG28#Teflon		
Lead Length	standard 300mm(adjutable)			
Insulation Strength	500VAC@50Hz, 60s			
Electrical Noise	<0.01Ω			

Part# List

MAPH600S-XX Pneumatic/Hydraulic Slip Ring
 1) XX=01,connection size=M5 Pipe size3~6mm
 2) XX=02,connection size=G1/8" Pipe size3~10mm
 3) XX=03,connection size=G1/4" Pipe size3~12mm

Part#	Pneumatic/Hydraulic Passage	10A	Signal or 2A	Length (mm)
MAPH600S-XX-S06	6 passages	0	6	19
MAPH600S-XX-S12	6 passages	0	12	26
MAPH600S-XX-S18	6 passages	0	18	33
MAPH600S-XX-S24	6 passages	0	24	43.6
MAPH600S-XX-S36	6 passages	0	36	57.3
MAPH600S-XX-S56	6 passages	0	56	85.7

Note:N channels 10A rings parallel can be used as 1 channel N*10A current. For example: 2 rings 10A parallel can be used as 1 wires 20A. 10A and Signal(5A) can be combine in any way as you need.Max.ring:96 rings,can be customized based on standard slip rings.Please contact us.

Product Quality Level Table

Products Level Code	Max Rotating Speed	Working Life	Sealing Element
VC	100RPM	10 Million Revs	Common Seals
VD	300RPM	30 Million Revs	High-Quality Seals

Lead Wires Color Code

Ring	1	2	3	4	5	6	7	8	9	10	11	12
Color	RED	GRN	YLW	VLT	GRY	BLK	BLU	DK BL	BN	OG	WHT	OCH

(6 wires for 1 group color, from 7-12, repeat the same color as 1...6, indicated with number code pipe)

Options for custom slip ring

Note: Below special demands can be customized. According, the delivery date will be extended 3 to 15 days; also the cost will be increased 30% to 50%. Most of our basic parts are standard and modular, which can save the cost and lead time.

- ① Cable exit way and cable length can be customized for both rotor and stator.
- ② Because of the structure limitation, length/height/OD can be customized on your request.
- ③ Support current or signal up to 200 rings.
- ④ Aviation plug, terminal and heat-shrink tube are optional.
- ⑤ Hybrid slip ring for Yaskawa/Panasonic/Siemens servo control signal, power line and encoder line.
- ⑥ Support mixed high speed data transmission (including Ethernet, USB, RS232, RS485, Profibus, CanBUS, CANOPEN, DeviceNET, CC-LINK, ProfiNET, EtherCAT, etc.)
- ⑦ Can combine temperature control signal with thermocouple signal.
- ⑧ Special environment can be customized, such as quakeproof, high temperature, etc.
- ⑨ Hybrid Pneumatic/hydraulic and electric slip ring can be mixed.
- ⑩ High temperature can up to 500 degrees.
- ⑪ High pressure can up to 110KV
- ⑫ Rotating speed can up to 10000RPM
- ⑬ Maximum current can up to 5000 amperes.
- ⑭ Military grade
- ⑮ Optional for underwater IP65, IP68.
- ⑯ Optional for stainless steel housing

Technical support: technical@moflon.com

Web: <http://www.moflon.com> Email: sales@moflon.com

MAPH800

8 Passages Fluid Electrical Slip Ring



MAPH800 is 8 passages Pneumatic /Hydraulic + 2~96rings Electrical Slip Ring.
 Connection size including: M5,G1/8", G1/4", G3/8",G1/2" and bigger on request.
 Electrical rings including power wire, signal wire,Ethernet, USB, Industrial BUS, control Net, and all kinds of sensitive signal, etc. Normally use flange for installation, hollow shaft intallation on request.
 Media Types: Air/Gas,hydrogen,Nitrogen,Chemical, Water,Oil,etc.

Part# Explanation

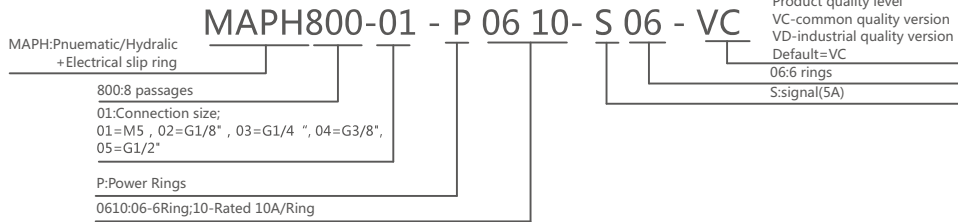

8 Passages , M5 MAPH800-01 Dimensions

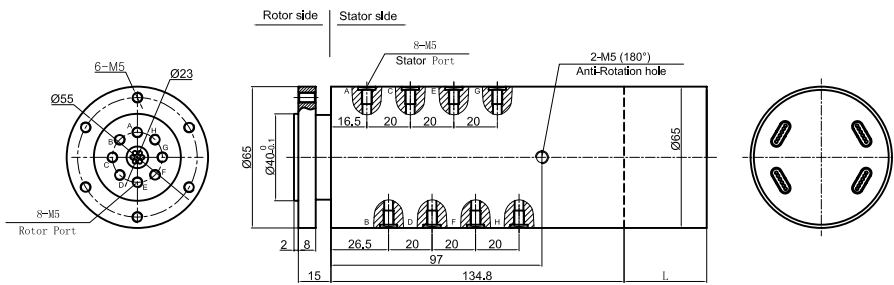

8 Passages , G1/8 MAPH800-02 Dimensions

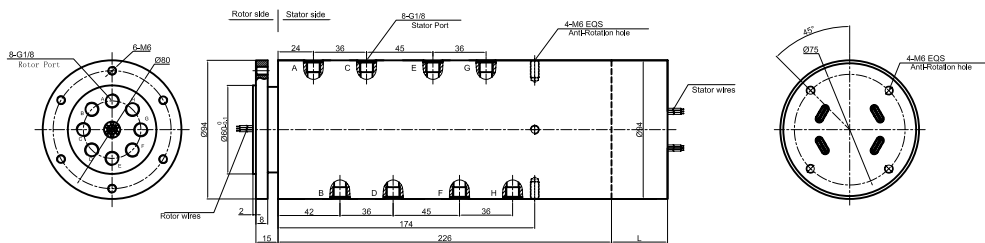

8 Passages , G1/4 MAPH800-03 Dimensions

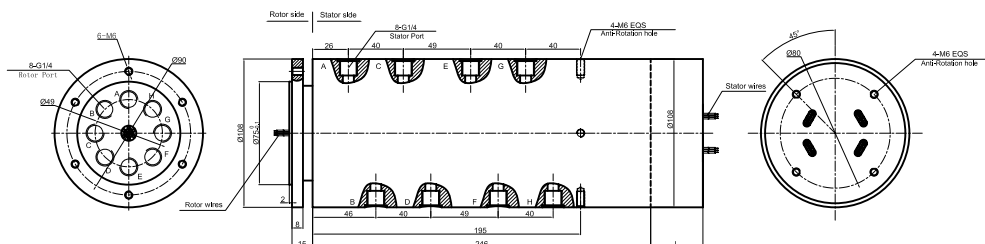

Specifications

Rotary Union Specifications			Mechanical Data	
Parameter	Value		Parameter	Value
Passage	8 passages		Working life	See Product Quality Level Table
Max Pressure	10MPa, Vacuum 0.01torr		Rotating Speed	See Product Quality Level Table
Torque	depend on connection size		Working Temperature	-30°C~80°C
Electrical Data			Operating Humidity	0~85% RH
Parameter	Value		Contact Material	Precious Metal
	Power	Signal	Housing Material	Aluminium Alloy
Rated Voltage	0~440VAC/VDC	0~440VAC/VDC	Protection Grade	IP51
Insulation Resistance	≥1000MΩ/500VDC	≥1000MΩ/500VDC		
Lead Wires	AWG17#Teflon	AWG22#Teflon		
Lead Length	standard 300mm(adjustable)			
Insulation Strength	500VAC@50Hz, 60s			
Electrical Noise	<0.01Ω			

Part# List

MAPH800-XX Pneumatic/Hydraulic Slip Ring
 1) XX=01,connection size=M5 Pipe size3~6mm
 2) XX=02connection size=G1/8" Pipe size3~10mm
 3) XX=03,connection size=G1/4" Pipe size3~12mm

Part#	Pneumatic/Hydraulic Passage	10A	Signal or 5A	Length (mm)	Part#	Pneumatic/Hydraulic Passage	10A	Signal or 5A	Length (mm)
MAPH800-XX-S06	8 passages	0	6	38	MAPH800-XX-P0810-S10	8 passages	8	10	71.6
MAPH800-XX-P0210-S04	8 passages	2	4	38	MAPH800-XX-P1010-S08	8 passages	10	8	71.6
MAPH800-XX-P0410-S02	8 passages	4	2	38	MAPH800-XX-P1210-S06	8 passages	12	6	71.6
MAPH800-XX-P0610	8 passages	6	0	38	MAPH800-XX-P1410-S04	8 passages	14	4	71.6
MAPH800-XX-S12	8 passages	12	0	54.8	MAPH800-XX-P1610-S02	8 passages	16	2	71.6
MAPH800-XX-P0210-S10	8 passages	2	10	54.8	MAPH800-XX-S24	8 passages	0	24	88.4
MAPH800-XX-P0310-S09	8 passages	3	9	54.8	MAPH800-XX-P0410-S20	8 passages	4	20	88.4
MAPH800-XX-P0610-S06	8 passages	6	6	54.8	MAPH800-XX-P0610-S18	8 passages	6	18	88.4
MAPH800-XX-P0810-S04	8 passages	8	4	54.8	MAPH800-XX-P1210-S12	8 passages	12	12	88.4
MAPH800-XX-P1010-S02	8 passages	10	2	54.8	MAPH800-XX-S30	8 passages	0	30	105.2
MAPH800-XX-P1210	8 passages	12	0	54.8	MAPH800-XX-P0610-S24	8 passages	6	24	105.2
MAPH800-XX-S18	8 passages	0	18	71.6	MAPH800-XX-S36	8 passages	0	36	125
MAPH800-XX-P0210-S16	8 passages	2	16	71.6	MAPH800-XX-S42	8 passages	0	42	141.8
MAPH800-XX-P0410-S14	8 passages	4	14	71.6	MAPH800-XX-S48	8 passages	0	48	158.6
MAPH800-XX-P0610-S12	8 passages	6	12	71.6					

Note:N channels 10A rings parallel can be used as 1 channel N*10A current. For example: 2 rings 10A parallel could be used as 1 wires 20A.
 10A and Signal(5A) can be combine in any way as you need.Max.ring:96 rings,can be customized based on standard slip rings.Please contact us.

Product Quality Level Table

Products Level Code	Max Rotating Speed	Working Life	Sealing Element
VC	100RPM	10 Million Revs	Common Seals
VD	300RPM	30 Million Revs	High-Quality Seals

Lead Wires Color Code

Ring	1	2	3	4	5	6	7	8	9	10	11	12
Color	BLK	RED	YLW	GRN	BLU	WHT	BLK	RED	YLW	GRN	BLU	WHT

(6 wires for 1 group color, from 7-12, repeat the same color as 1...6, indicated with number code pipe)

Options for custom slip ring

Note : Below special demands can be customized. According, the delivery date will be extended 3 to 15 days; also the cost will be increased 30% to 50%. Most of our basic parts are standard and modular, which can save the cost and lead time.

- ① Cable exit way and cable length can be customized for both rotor and stator.
- ② Because of the structure limitation, length/height/OD can be customized on your request.
- ③ Support current or signal up to 200 rings.
- ④ Aviation plug, terminal and heat-shrink tube are optional.
- ⑤ Hybrid slip ring for Yaskawa/Panasonic/Siemens servo control signal, power line and encoder line.

- ⑦ Can combine temperature control signal with thermocouple signal.
 - ⑧ Special environment can be customized, such as quakeproof, high temperature, etc.
 - ⑨ Hybrid Pneumatic/hydraulic and electric slip ring can be mixed.
 - ⑩ High temperature can up to 500 degrees.
 - ⑪ High voltage can up to 110KV
 - ⑫ Rotating speed can up to 10000RPM
 - ⑬ Maximum current can up to 5000 amperes.
 - ⑭ Military grade
 - ⑮ Optional for underwater IP65, IP68.
 - ⑯ Optional for stainless steel housing
- Technical support : technical@moflon.com

MAPH1000

10 Passages Fluid Electrical Slip Ring



MAPH1000 is 10 passages Pneumatic /Hydraulic + 2~96rings Electrical Slip Ring. Connection size including: M5,G1/8", G1/4", G3/8",G1/2" and bigger on request. Electrical rings including power wire, signal wire,Ethernet, USB, Industrial BUS, control Net, and all kinds of sensitive signal, etc. Normally use flange for installation, hollow shaft intallation on request. Media Types: Air/Gas,hydrogen,Nitrogen,Chemical, Water,Oil,etc.

Part# Explanation

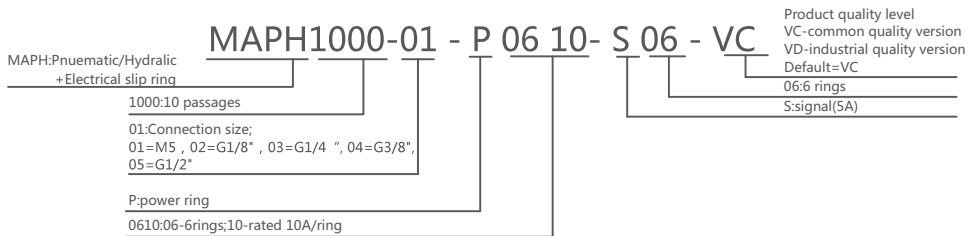

10Passages , M5 MAPH1040-01 Dimensions

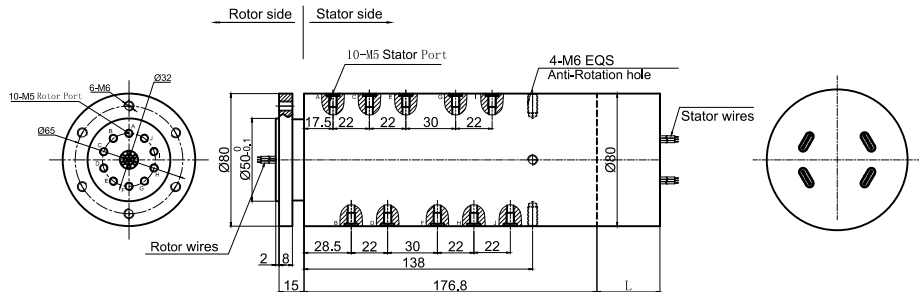

Part# List

MAPH1000-01 Pneumatic/Hydraulic Slip Ring

1) XX=01,connection size=M5, Pipe size3~6mm

Part#	Pneumatic/Hydraulic Passage	10A	Signal or 5A	Length (mm)	Part#	Pneumatic/Hydraulic Passage	10A	Signal or 5A	Length (mm)
MAPH1000-01-S06	10 passages	0	6	38	MAPH1000-01-P0810-S10	10 passages	8	10	71.6
MAPH1000-01-P0210-S04	10 passages	2	4	38	MAPH1000-01-P1010-S08	10 passages	10	8	71.6
MAPH1000-01-P0410-S02	10 passages	4	2	38	MAPH1000-01-P1210-S06	10 passages	12	6	71.6
MAPH1000-01-P0610	10 passages	6	0	38	MAPH1000-01-P1410-S04	10 passages	14	4	71.6
MAPH1000-01-S12	10 passages	12	0	54.8	MAPH1000-01-P1610-S02	10 passages	16	2	71.6
MAPH1000-01-P0210-S10	10 passages	2	10	54.8	MAPH1000-01-S24	10 passages	0	24	88.4
MAPH1000-01-P0310-S09	10 passages	3	9	54.8	MAPH1000-01-P0410-S20	10 passages	4	20	88.4
MAPH1000-01-P0610-S06	10 passages	6	6	54.8	MAPH1000-01-P0610-S18	10 passages	6	18	88.4
MAPH1000-01-P0810-S04	10 passages	8	4	54.8	MAPH1000-01-P1210-S12	10 passages	12	12	88.4
MAPH1000-01-P1010-S02	10 passages	10	2	54.8	MAPH1000-01-S30	10 passages	0	30	105.2
MAPH1000-01-P1210	10 passages	12	0	54.8	MAPH1000-01-P0610-S24	10 passages	6	24	105.2
MAPH1000-01-S18	10 passages	0	18	71.6	MAPH1000-01-S36	10 passages	0	36	125
MAPH1000-01-P0210-S16	10 passages	2	16	71.6	MAPH1000-01-S42	10 passages	0	42	141.8
MAPH1000-01-P0410-S14	10 passages	4	14	71.6	MAPH1000-01-S48	10 passages	0	48	158.6
MAPH1000-01-P0610-S12	10 passages	6	12	71.6					

Note:N channels 10A rings parallel can be used as 1 channel N*10A current. For example: 2 rings 10A parallel could be used as 1 wires 20A.

10A and Signal(5A) can be combine in any way as you need.Max.ring:96 rings,can be customized based on standard slip rings.Please contact us.

Specifications

Rotary Union Specification		
Parameter	Value	
Passage	10 passages	
Max .Pressure	10MPa , Vacuum 0.01torr	
Torque	depend on conection size	
Electrical Data		
Parameter	Value	
	Power	Signal
Rated Voltage	0~440VAC/VDC	0~440VAC/VDC
Insulation Resistance	≥1000MΩ/500VDC	≥1000MΩ/500VDC
Lead Wires	AWG17#Teflon	AWG22#Teflon
Lead Length	standard 300mm(adjustable)	
Insulation Strength	500VAC@50Hz , 60s	
Electrical Noise	<0.01Ω	
Mechanical Data		
Parameter	Value	
Working Life	See Product Quality Level Table	
Rotating Speed	See Product Quality Level Table	
Working Temperature	-30°C~80°C	
Operating Humidity	0~85% RH	
Contact Material	Precious Metal	
Housing Material	Aluminium Alloy	
Protection Grade	IP51	

Product Quality Level Table

Products Level Code	Max Rotating Speed	Working Life	Sealing Element
VC	100RPM	10 Million Revs	Common Seals
VD	300RPM	30 Million Revs	High-Quality Seals

Lead Wires Color Code

Ring	1	2	3	4	5	6	7	8	9	10	11	12
Color	BLK	RED	YLW	GRN	BLU	WHT	BLK	RED	YLW	GRN	BLU	WHT

(6 wires for 1 group color, from 7-12, repeat the same color as 1...6, indicated with number code pipe)

Options for custom slip ring

Note: Below special demands can be customized. According, the delivery date will be extended 3 to 15 days; also the cost will be increased 30% to 50%. Most of our basic parts are standard and modular, which can save the cost and lead time.

- ① Cable exit way and cable length can be customized for both rotor and stator.
- ② Because of the structure limitation, length/height/OD can be customized on your request.
- ③ Support current or signal up to 200 rings.
- ④ Aviation plug, terminal and heat-shrink tube are optional.
- ⑤ Hybrid slip ring for Yaskawa/Panasonic/Siemens servo control signal, power line and encoder line.
- ⑥ Support mixed high speed data transmission (including Ethernet, USB, RS232, RS485, Profibus, CanBUS, CANOPEN, DeviceNET, CC-LINK, ProfiNET, EtherCAT, etc.)
- ⑦ Can combine temperature control signal with thermocouple signal.
- ⑧ Special environment can be customized, such as quakeproof, high temperature, etc.
- ⑨ Hybrid Pneumatic/hydraulic and electric slip ring can be mixed.
- ⑩ High temperature can up to 500 degrees.
- ⑪ High pressure can up to 110KV
- ⑫ Rotating speed can up to 10000RPM
- ⑬ Maximum current can up to 5000 amperes.
- ⑭ Military grade
- ⑮ Optional for underwater IP65, IP68.
- ⑯ Optional for stainless steel housing

Technical support: technical@moflon.com

MAPH1200

12 Passages Fluid Electrical Slip Ring

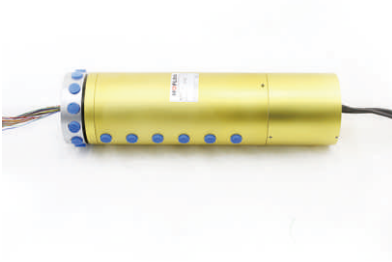

MAPH1200 is 12 passages Pneumatic /Hydraulic + 2~96rings Electrical Slip Ring. Connection size including: M5,G1/8", G1/4", G3/8",G1/2" and bigger on request. Electrical rings including power wire, signal wire,Ethernet, USB, Industrial BUS, control Net, and all kinds of sensitive signal, etc. Normally use flange for installation, hollow shaft intallation on request. Media Types: Air/Gas,hydrogen,Nitrogen,Chemical, Water,Oil,etc.

Part# Explanation

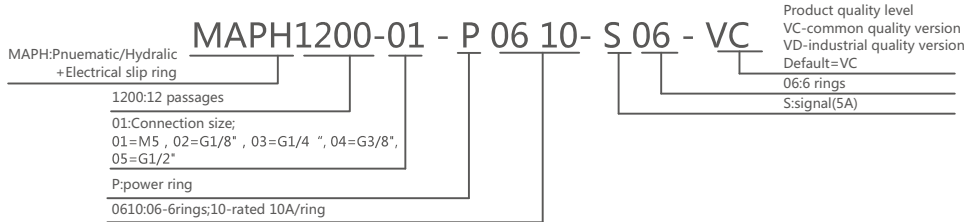

12Passages , M5 MAPH1200-01 Dimensions

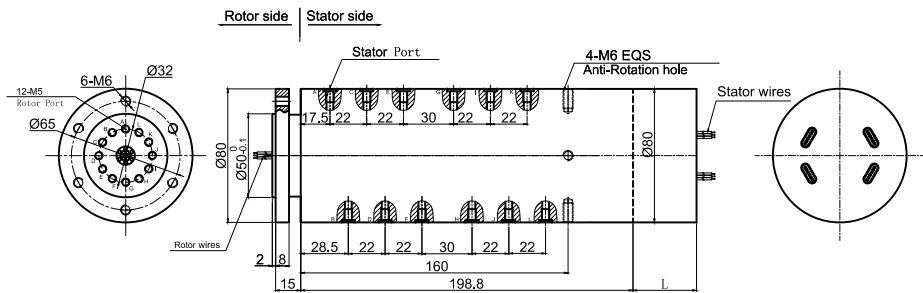

Part# List

MAPH1200-01 Pneumatic/Hydraulic Slip Ring
1) XX=01,connection size=M5 , Pipe size3~6mm

Part#	Pneumatic/Hydraulic Passage	10A	Signal or 5A	Length (mm)	Part#	Pneumatic/Hydraulic Passage	10A	Signal or 5A	Length (mm)
MAPH1200-01-S06	12 passages	0	6	38	MAPH1200-01-P0810-S10	12 passages	8	10	71.6
MAPH1200-01-P0210-S04	12 passages	2	4	38	MAPH1200-01-P1010-S08	12 passages	10	8	71.6
MAPH1200-01-P0410-S02	12 passages	4	2	38	MAPH1200-01-P1210-S06	12 passages	12	6	71.6
MAPH1200-01-P0610	12 passages	6	0	38	MAPH1200-01-P1410-S04	12 passages	14	4	71.6
MAPH1200-01-S12	12 passages	12	0	54.8	MAPH1200-01-P1610-S02	12 passages	16	2	71.6
MAPH1200-01-P0210-S10	12 passages	2	10	54.8	MAPH1200-01-S24	12 passages	0	24	88.4
MAPH1200-01-P0310-S09	12 passages	3	9	54.8	MAPH1200-01-P0410-S20	12 passages	4	20	88.4
MAPH1200-01-P0610-S06	12 passages	6	6	54.8	MAPH1200-01-P0610-S18	12 passages	6	18	88.4
MAPH1200-01-P0810-S04	12 passages	8	4	54.8	MAPH1200-01-P1210-S12	12 passages	12	12	88.4
MAPH1200-01-P1010-S02	12 passages	10	2	54.8	MAPH1200-01-S30	12 passages	0	30	105.2
MAPH1200-01-P1210	12 passages	12	0	54.8	MAPH1200-01-P0610-S24	12 passages	6	24	105.2
MAPH1200-01-S18	12 passages	0	18	71.6	MAPH1200-01-S36	12 passages	0	36	125
MAPH1200-01-P0210-S16	12 passages	2	16	71.6	MAPH1200-01-S42	12 passages	0	42	141.8
MAPH1200-01-P0410-S14	12 passages	4	14	71.6	MAPH1200-01-S48	12 passages	0	48	158.6
MAPH1200-01-P0610-S12	12 passages	6	12	71.6					

Note:N channels 10A rings parallel can be used as 1 channel N*10A current. For example: 2 rings 10A parallel could be used as 1 wires 20A. 10A and Signal(5A) can be combine in any way as you need.Max.ring:96 rings,can be customized based on standard slip rings.Please contact us.

Specifications

Rotary Union Specification		
Parameter	Value	
Passage	12 passages	
Max .Pressure	10MPa , Vacuum 0.01torr	
Torque	depend on conection size	
Electrical Data		
Parameter	Value	
	Power	Signal
Rated Voltage	0~440VAC/VDC	0~440VAC/VDC
Insulation Resistance	≥1000MΩ/500VDC	≥1000MΩ/500VDC
Lead Wires	AWG17#Teflon	AWG22#Teflon
Lead Length	standard 300mm(adjustable)	
Insulation Strength	500VAC@50Hz , 60s	
Electrical Noise	<0.01Ω	
Mechanical Data		
Parameter	Value	
Working Life	See Product Quality Level Table	
Rotating Speed	See Product Quality Level Table	
Working Temperature	-30°C~80°C	
Operating Humidity	0~85% RH	
Contact Material	Precious Metal	
Housing Material	Aluminium Alloy	
Protection Grade	IP51	

Product Quality Level Table

Products Level Code	Max Rotating Speed	Working Life	Sealing Element
VC	100RPM	10 Million Revs	Common Seals
VD	300RPM	30 Million Revs	High-Quality Seals

Lead Wires Color Code

Ring	1	2	3	4	5	6	7	8	9	10	11	12
Color	BLK	RED	YLW	GRN	BLU	WHT	BLK	RED	YLW	GRN	BLU	WHT

(6 wires for 1 group color, from 7-12, repeat the same color as 1...6, indicated with number code pipe)

Options for custom slip ring

Note: Below special demands can be customized. According, the delivery date will be extended 3 to 15 days; also the cost will be increased 30% to 50%. Most of our basic parts are standard and modular, which can save the cost and lead time.

- ① Cable exit way and cable length can be customized for both rotor and stator.
- ② Because of the structure limitation, length/height/OD can be customized on your request.
- ③ Support current or signal up to 200 rings.
- ④ Aviation plug, terminal and heat-shrink tube are optional.
- ⑤ Hybrid slip ring for Yaskawa/Panasonic/Siemens servo control signal, power line and encoder line.
- ⑥ Support mixed high speed data transmission (including Ethernet, USB, RS232, RS485, Profibus, CanBUS, CANOPEN, DeviceNET, CC-LINK, ProfiNET, EtherCAT, etc.)
- ⑦ Can combine temperature control signal with thermocouple signal.
- ⑧ Special environment can be customized, such as quakeproof, high temperature, etc.
- ⑨ Hybrid Pneumatic/hydraulic and electric slip ring can be mixed.
- ⑩ High temperature can up to 500 degrees.
- ⑪ High pressure can up to 110KV
- ⑫ Rotating speed can up to 10000RPM
- ⑬ Maximum current can up to 5000 amperes.
- ⑭ Military grade
- ⑮ Optional for underwater IP65, IP68.
- ⑯ Optional for stainless steel housing

Technical support: technical@moflon.com

MAPH1600

16 Passages Fluid Electrical Slip Ring



MAPH1600 is 16 passages Pneumatic /Hydraulic + 2~96rings Electrical Slip Ring. Connection size including: M5,G1/8", G1/4", G3/8",G1/2" and bigger on request. Electrical rings including power wire, signal wire,Ethernet, USB, Industrial BUS, control Net, and all kinds of sensitive signal, etc. Normally use flange for installation, hollow shaft intallation on request.

Media Types: Air/Gas,hydrogen,Nitrogen,Chemical, Water,Oil,etc.

Part# Explanation

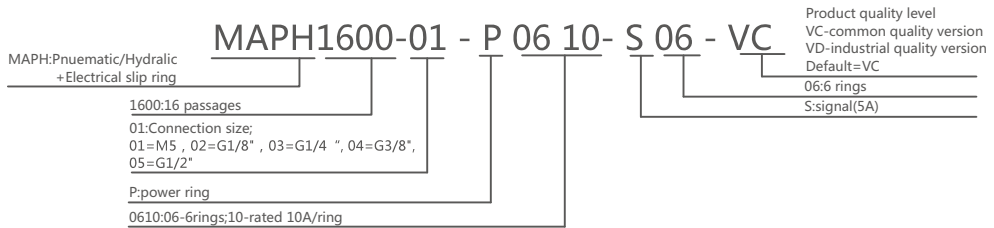

16 Passages , M5 MAPH1600-01 Dimensions

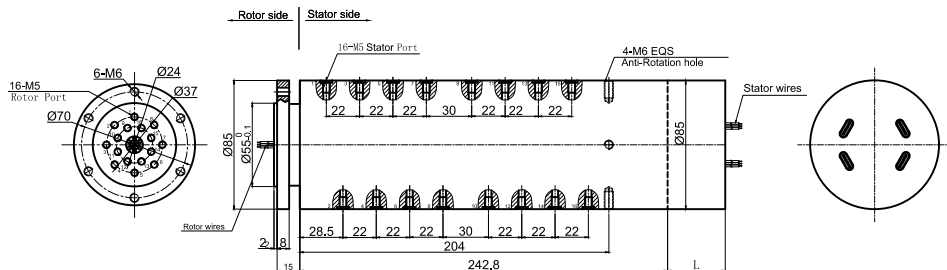

Part# List

MAPH1600-01 Pneumatic/Hydraulic Slip Ring
1) XX=01,connection size=M5, Pipe size3~6mm

Part#	Pneumatic/Hydraulic Passage	10A	Signal or 5A	Length (mm)	Part#	Pneumatic/Hydraulic Passage	10A	Signal or 5A	Length (mm)
MAPH1600-01-S06	16 passages	0	6	38	MAPH1600-01-P0810-S10	16 passages	8	10	71.6
MAPH1600-01-P0210-S04	16 passages	2	4	38	MAPH1600-01-P1010-S08	16 passages	10	8	71.6
MAPH1600-01-P0410-S02	16 passages	4	2	38	MAPH1600-01-P1210-S06	16 passages	12	6	71.6
MAPH1600-01-P0610	16 passages	6	0	38	MAPH1600-01-P1410-S04	16 passages	14	4	71.6
MAPH1600-01-S12	16 passages	12	0	54.8	MAPH1600-01-P1610-S02	16 passages	16	2	71.6
MAPH1600-01-P0210-S10	16 passages	2	10	54.8	MAPH1600-01-S24	16 passages	0	24	88.4
MAPH1600-01-P0310-S09	16 passages	3	9	54.8	MAPH1600-01-P0410-S20	16 passages	4	20	88.4
MAPH1600-01-P0610-S06	16 passages	6	6	54.8	MAPH1600-01-P0610-S18	16 passages	6	18	88.4
MAPH1600-01-P0810-S04	16 passages	8	4	54.8	MAPH1600-01-P1210-S12	16 passages	12	12	88.4
MAPH1600-01-P1010-S02	16 passages	10	2	54.8	MAPH1600-01-S30	16 passages	0	30	105.2
MAPH1600-01-P1210	16 passages	12	0	54.8	MAPH1600-01-P0610-S24	16 passages	6	24	105.2
MAPH1600-01-S18	16 passages	0	18	71.6	MAPH1600-01-S36	16 passages	0	36	125
MAPH1600-01-P0210-S16	16 passages	2	16	71.6	MAPH1600-01-S42	16 passages	0	42	141.8
MAPH1600-01-P0410-S14	16 passages	4	14	71.6	MAPH1600-01-S48	16 passages	0	48	158.6
MAPH1600-01-P0610-S12	16 passages	6	12	71.6					

Note:N channels 10A rings parallel can be used as 1 channel N*10A current. For example: 2 rings 10A parallel could be used as 1 wires 20A.

10A and Signal(5A) can be combine in any way as you need.Max.ring:96 rings,can be customized based on standard slip rings.Please contact us.

Specifications

Rotary Union Specification		
Parameter	Value	
Passage	12 passages	
Max .Pressure	10MPa , Vacuum 0.01torr	
Torque	depend on conection size	
Electrical Data		
Parameter	Value	
	Power	Signal
Rated Voltage	0~440VAC/VDC	0~440VAC/VDC
Insulation Resistance	≥1000MΩ/500VDC	≥1000MΩ/500VDC
Lead Wires	AWG17#Teflon	AWG22#Teflon
Lead Length	standard 300mm(adjustable)	
Insulation Strength	500VAC@50Hz , 60s	
Electrical Noise	<0.01Ω	
Mechanical Data		
Parameter	Value	
Working Life	See Product Quality Level Table	
Rotating Speed	See Product Quality Level Table	
Working Temperature	-30°C~80°C	
Operating Humidity	0~85% RH	
Contact Material	Precious Metal	
Housing Material	Aluminium Alloy	
Protection Grade	IP51	

Product Quality Level Table

Products Level Code	Max Rotating Speed	Working Life	Sealing Element
VC	100RPM	10 Million Revs	Common Seals
VD	300RPM	30 Million Revs	High-Quality Seals

Lead Wires Color Code

Ring	1	2	3	4	5	6	7	8	9	10	11	12
Color	BLK	RED	YLW	GRN	BLU	WHT	BLK	RED	YLW	GRN	BLU	WHT

(6 wires for 1 group color, from 7-12, repeat the same color as 1...6, indicated with number code pipe)

Options for custom slip ring

Note: Below special demands can be customized. According, the delivery date will be extended 3 to 15 days; also the cost will be increased 30% to 50%. Most of our basic parts are standard and modular, which can save the cost and lead time.

- ① Cable exit way and cable length can be customized for both rotor and stator.
- ② Because of the structure limitation, length/height/OD can be customized on your request.
- ③ Support current or signal up to 200 rings.
- ④ Aviation plug, terminal and heat-shrink tube are optional.
- ⑤ Hybrid slip ring for Yaskawa/Panasonic/Siemens servo control signal, power line and encoder line.
- ⑥ Support mixed high speed data transmission (including Ethernet, USB, RS232, RS485, Profibus, CanBUS, CANOPEN, DeviceNET, CC-LINK, ProfiNET, EtherCAT, etc.)
- ⑦ Can combine temperature control signal with thermocouple signal.
- ⑧ Special environment can be customized, such as quakeproof, high temperature, etc.
- ⑨ Hybrid Pneumatic/hydraulic and electric slip ring can be mixed.
- ⑩ High temperature can up to 500 degrees.
- ⑪ High pressure can up to 110KV
- ⑫ Rotating speed can up to 10000RPM
- ⑬ Maximum current can up to 5000 amperes.
- ⑭ Military grade
- ⑮ Optional for underwater IP65, IP68.
- ⑯ Optional for stainless steel housing

Technical support: technical@moflon.com