

MK Series Rotary Unions(can combine with electric wires)



Features

- Light weight, compact size, and low torque.
 - Transmitting gas, vacuum on 360° rotating , can
- combine with electrical power, signal and/or data transfer.
- Support 1/2/3/4/5/6/8/10/12/16/24 Pneumatic passages.
- Support 1~128 wires electrical power/signal.
- Standard connection size G1/8", G3/8" and so on.
- Different pipe size for gas can be customized.
- Can transmit compressed air, vacuum, steam and other media.
- High speed and high voltage can be customized.

Part List

Mk Series Parts# List			
Part#	Passages	Connection Size	Pressure
MK11A	1 in 1 out	G1/8"	1MPa, Vacuum
MK12A	1 in 1 out	G1/4"	1MPa, Vacuum
MK13A	1 in 1 out	G3/8"	1MPa, Vacuum
MK14A	1 in 1 out	G1/2"	1MPa, Vacuum

MK series - G1/8" connection size parts list				
Model	Passages	Connection Size	adaptive tube	Circuit Number(power/signal(2A)
MK21	2 passages	G1/8"	6~8mm	Note:Pure pneumatic rotary union
MK21-XXX	2 passages	G1/8"	6~8mm	2~128 circuits electric
MK41	4 passages	G1/8"	6~8mm	Note:Pure pneumatic rotary union
MK41-XXX	4 passages	G1/8"	6~8mm	2~128 circuits electric
MK81	8 passages	G1/8"	6~8mm	Note:Pure pneumatic rotary union
MK81-XXX	8 passages	G1/8"	6~8mm	2~128 circuits electric
MK121	12 passages	G1/8"	6~8mm	Note:Pure pneumatic rotary union
MK121-XXX	12 passages	G1/8"	6~8mm	2~128 circuits electric
MK241	24 passages	G1/8"	6~8mm	Note:Pure pneumatic rotary union
MK241-XXX	24 passages	G1/8"	6~8mm	2~128 circuits electric

MK series - G3/8" connection size parts list				
Model	Passages	Connection Size	adaptive tube	Circuit Number(power/signal(2A)
MK23	2 passages	G3/8"	10~12mm	Note:Pure pneumatic rotary union
MK23-XXX	2 passages	G3/8"	10~12mm	2~128 circuits electric
MK43	4 passages	G3/8"	10~12mm	Note:Pure pneumatic rotary union
MK43+XXX	4 passages	G3/8"	10~12mm	2~128 circuits electric
MK83	8 passages	G3/8"	10~12mm	Note:Pure pneumatic rotary union
MK83+XXX	8 passages	G3/8"	10~12mm	2~128 circuits electric
MK123	12 passages	G3/8"	10~12mm	Note:Pure pneumatic rotary union
MK123+XXX	12 passages	G3/8"	10~12mm	2~128 circuits electric

MK11A(1 passages Pneumatic Rotary Union)



Mk11a series single channel rotary joint, interface size G1 / 8 ", compact structure, light weight, corrosion resistance, stainless steel shaft and aluminum shell All MK series models are equipped with male thread shaft and female thread shell as standard for easy installation.

Part# Explanation

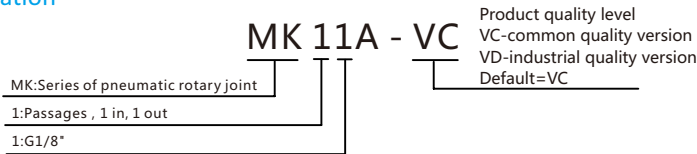

MK11A Dimensions

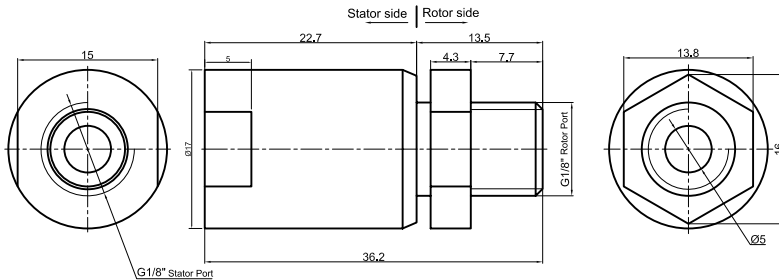

Part List

Mk 11A Series Parts# List			
Part#	Passages	Port Size	Pressure
MK11A	1 in 1 out	G1/8"	1MPa, Vacuum

Specification

Mechanical Data		Rotary Joint Data	
Parameter	Value	Parameter	Value
Working life	Please see the product quality level table	Passage	1 Passage
Rated Rotating Speed	Please see the product quality level table	Max Pressure	Vacuum-1MPa
Working Temperature	-30°C~80°C	Dielectric medium	Air , Vacuum
Operating Humidity	0~85% RH	Torque	Related to the connection size, please see the product selection table
Sealing Element	Please see the product quality level table		
Housing Material	Aluminum alloy / steel		
Protection Grade	IP51		

Product Quality Level Table

Products Level Code	Max Rotating Speed	Working Life	Sealing Element
VC	100RPM	6 Million Revs	Seals of domestic famous brand
VD	300RPM	20 Million Revs	Imported Sealing elemen

Options for custom slip ring

Note: Below special demands can be customized. According, the delivery date will be extended 3 to 15 days; also the cost will be increased 30% to 50%. Most of our basic parts are standard and modular, which can save the cost and lead time.

MK12A(1 passages Pneumatic Rotary Union)



Mk12a series single channel rotary joint, interface size G1 / 4 ", compact structure, light weight, corrosion resistance, stainless steel shaft and aluminum shell All MK series models are equipped with male thread shaft and female thread shell as standard for easy installation.

Part# Explanation

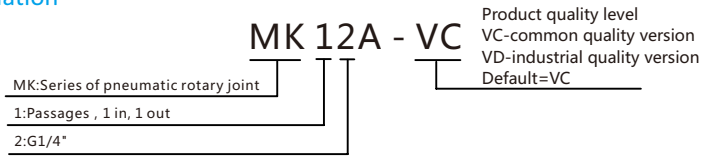

MK12A Dimensions

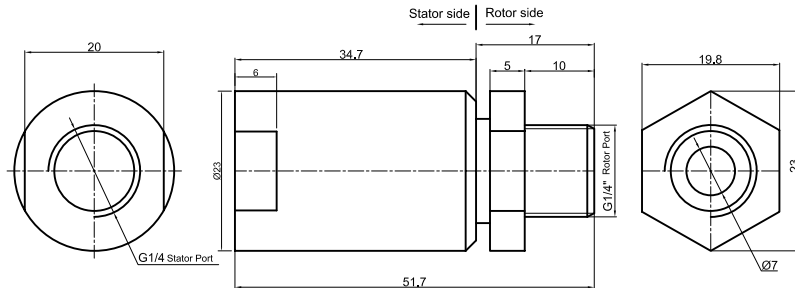

Part List

Mk 12A Series Parts# List			
Part#	Passages	Port Size	Pressure
MK12A	1 in 1 out	G1/4"	1MPa, Vacuum

Specification

Mechanical Data		Rotary Joint Data	
Parameter	Value	Parameter	Value
Working life	Please see the product quality level table	Passage	1 Passage
Rated Rotating Speed	Please see the product quality level table	Max Pressure	Vacuum-1MPa
Working Temperature	-30°C~80°C	Dielectric medium	Air , Vacuum
Operating Humidity	0~85% RH	Torque	Related to the connection size, please see the product selection table
Sealing Element	Please see the product quality level table		
Housing Material	Aluminum alloy / steel		
Protection Grade	IP51		

Product Quality Level Table

Products Level Code	Max Rotating Speed	Working Life	Sealing Element
VC	100RPM	6 Million Revs	Seals of domestic famous brand
VD	300RPM	20 Million Revs	Imported Sealing elemen

Options for custom slip ring

Note: Below special demands can be customized. According, the delivery date will be extended 3 to 15 days; also the cost will be increased 30% to 50%. Most of our basic parts are standard and modular, which can save the cost and lead time.

MK13A(1 passages Pneumatic Rotary Union)



Mk13a series single channel rotary joint, interface size G3 / 8 ", compact structure, light weight, corrosion resistance, stainless steel shaft and aluminum shell All MK series models are equipped with male thread shaft and female thread shell as standard for easy installation.

Part# Explanation

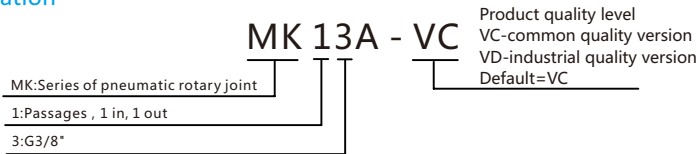

MK13A Dimensions

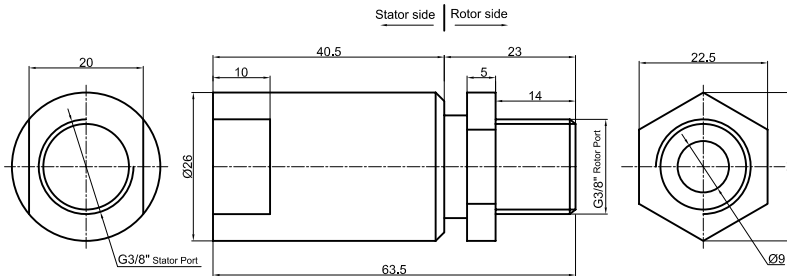

Part List

Mk 13A Series Parts# List			
Part#	Passages	Port Size	Pressure
MK13A	1 in 1 out	G3/8"	1MPa, Vacuum

Specification

Mechanical Data		Rotary Joint Data	
Parameter	Value	Parameter	Value
Working life	Please see the product quality level table	Passage	1 Passage
Rated Rotating Speed	Please see the product quality level table	Max Pressure	Vacuum-1MPa
Working Temperature	-30°C~80°C	Dielectric medium	Air , Vacuum
Operating Humidity	0~85% RH	Torque	Related to the connection size, please see the product selection table
Sealing Element	Please see the product quality level table		
Housing Material	Aluminum alloy / steel		
Protection Grade	IP51		

Product Quality Level Table

Products Level Code	Max Rotating Speed	Working Life	Sealing Element
VC	100RPM	6 Million Revs	Seals of domestic famous brand
VD	300RPM	20 Million Revs	Imported Sealing elemen

Options for custom slip ring

Note: Below special demands can be customized. According, the delivery date will be extended 3 to 15 days; also the cost will be increased 30% to 50%. Most of our basic parts are standard and modular, which can save the cost and lead time.

MK14A(1 passages Pneumatic Rotary Union)



Mk14a series single channel rotary joint, interface size G1 / 2 ", compact structure, light weight, corrosion resistance, stainless steel shaft and aluminum shell All MK series models are equipped with male thread shaft and female thread shell as standard for easy installation.

Part# Explanation

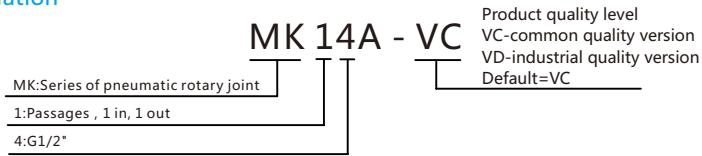

MK14A Dimensions

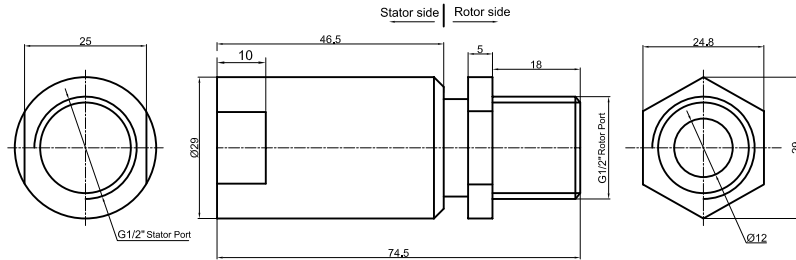

Part List

Mk 14A Series Parts# List			
Part#	Passages	Port Size	Pressure
MK14A	1 in 1 out	G1/2"	1MPa, Vacuum

Specification

Mechanical Data		Rotary Joint Data	
Parameter	Value	Parameter	Value
Working life	Please see the product quality level table	Passage	1 Passage
Rated Rotating Speed	Please see the product quality level table	Max Pressure	Vacuum-1MPa
Working Temperature	-30°C~80°C	Dielectric medium	Air , Vacuum
Operating Humidity	0~85% RH	Torque	Related to the connection size, please see the product selection table
Sealing Element	Please see the product quality level table		
Housing Material	Aluminum alloy / steel		
Protection Grade	IP51		

Product Quality Level Table

Products Level Code	Max Rotating Speed	Working Life	Sealing Element
VC	100RPM	6 Million Revs	Seals of domestic famous brand
VD	300RPM	20 Million Revs	Imported Sealing elemen

Options for custom slip ring

Note: Below special demands can be customized. According, the delivery date will be extended 3 to 15 days; also the cost will be increased 30% to 50%. Most of our basic parts are standard and modular, which can save the cost and lead time.

MK21(2 passages Pneumatic Rotary Union--Can combine electric wires)



MK21 series is 2 passages Pneumatic Rotary Union(Can combine electric wires), with connection size G1/8", compact size, light weight, low torque, Also optional for transmitting power line, signal line, industrial bus, control line, Electromagnetic valve, induction line, etc.; Standard installation is flange mounting.
Media Types: compressed Air/Gas, vacuum, etc.

MK21 (rotary union only for pneumatic) drawing (2 in 2 out, connection size G1/8")

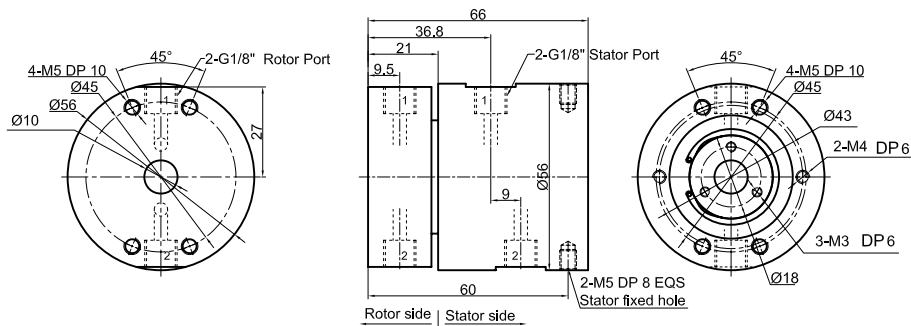

Part list

Model	Passages	Connection Size	Adaptive tube
MK21	2	G1/8"	6~8mm

MK21S-S12 drawing 2 in 2 out, connection size G1/8"+12~36 wires x signal(2A)

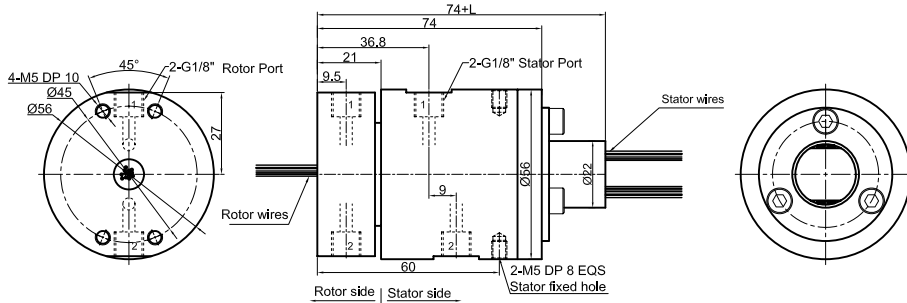

Part list

Model	Passages	Connection Size	Adaptive tube	Signal(2A)	L(mm)
MK21S-S12	2	G1/8"	6~8mm	12	22.5
MK21S-S18	2	G1/8"	6~8mm	18	29.5
MK21S-S24	2	G1/8"	6~8mm	24	40.1
MK21S-S36	2	G1/8"	6~8mm	36	53.8

MK21S-S56 drawing 2 in 2 out, connection size G1/8"

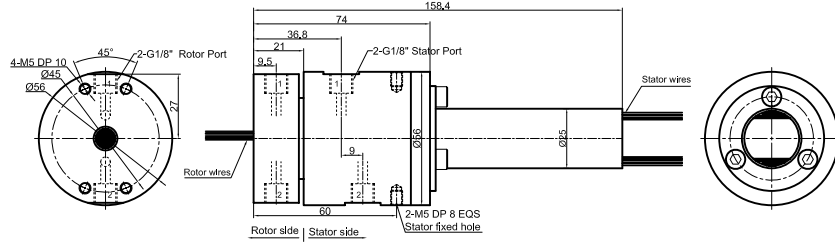

Part list

Model	Passages	Connection Size	Adaptive tube	Signal(2A)
MK21S-S56	2	G1/8"	6~8mm	56

MK21-PXX-SXX drawing 2 in 2 out, connection size G1/8" + signal(5A)/10A

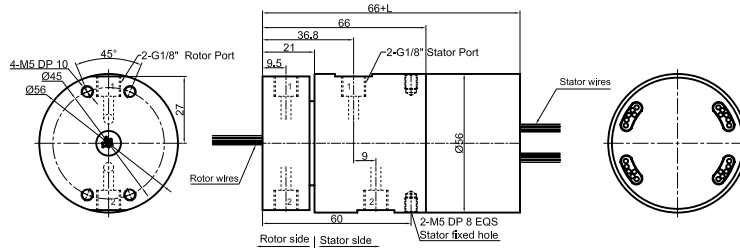

Part list

Model	Passages	Connection Size	Adaptive tube	10A	Signal(5A)	L(mm)
MK21-P0610	2	G1/8"	6~8mm	6	0	38
MK21-S06	2	G1/8"	6~8mm	0	6	38
MK21-P1210	2	G1/8"	6~8mm	12	0	54.8
MK21-P0610-S06	2	G1/8"	6~8mm	6	6	54.8
MK21-S12	2	G1/8"	6~8mm	0	12	54.8
MK21-P1810	2	G1/8"	6~8mm	18	0	71.5
MK21-P0610-S12	2	G1/8"	6~8mm	6	12	71.5
MK21-P1210-S06	2	G1/8"	6~8mm	12	6	71.5
MK21-S18	2	G1/8"	6~8mm	0	18	71.5
MK21-S24	2	G1/8"	6~8mm	0	24	88.4
MK21-P0610-S18	2	G1/8"	6~8mm	6	18	88.4
MK21-S30	2	G1/8"	6~8mm	0	30	105.2
MK21-S36	2	G1/8"	6~8mm	0	36	125

Note:10A and signal(5A) can be freely combined, please contact customer service for details.

Specifications

Rotary Union Specifications			Mechanical data	
Parameter	Value		Parameter	Value
Passage	2 in 2 out, G1/8"		Working life	Over 10 Million Revs
Max Pressure	1MPa(high pressure can be customized), Vacuum 0.01torr		Rated Rotating Speed	500RPM
Torque	Related to the connection size, please see the product selection table		Working Temperature	-30°C~80°C
Electrical Data			Operating Humidity	0~85% RH
Parameter	Value		Contact Material	Precious Metal
	Power	Signal	Housing Material	Aluminium Alloy
Rated Voltage	0~240VAC/VDC	0~240VAC/VDC	Protection Grade	IP51
Insulation Resistance	≥500MΩ/500VDC	≥500MΩ/500VDC		
Lead Wires	AWG17#Teflon/PVC	AWG22#Teflon/PVC		
Lead Length	Standard 300mm(adjustable on request)			
Dielectric Strength	500VAC@50Hz, 60s			
Electrical Noise	<0.01Ω			

MK23(2 passages Pneumatic Rotary Union--Can combine electric wires)



MK23 series is 2 passages Pneumatic Rotary Union(Can combine electric wires), with connection size G3/8", compact size, light weight, low torque, Also optional for transmitting power line, signal line, industrial bus, control line, Electromagnetic valve, induction line, etc.; Standard installation is flange mounting.
Media Types: compressed Air/Gas, vacuum, etc.

MK23 (rotary union only for pneumatic) drawing (2 in 2 out, connection size G3/8")

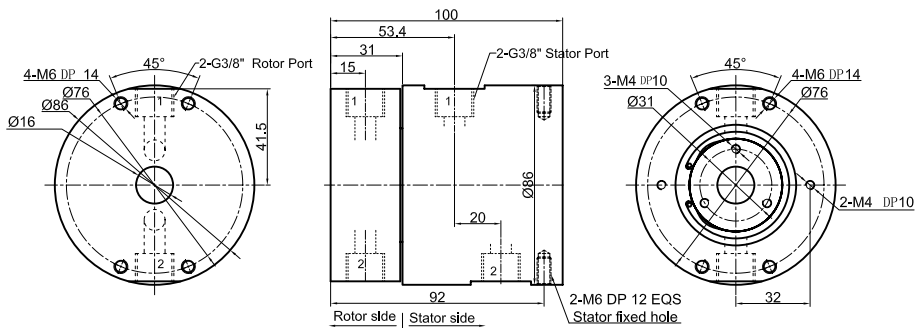

Part list

Model	Passages	Connection Size	Adaptive tube
MK23	2	G3/8"	10~12mm

MK23S-S12 drawing 2 in 2 out, connection size G3/8" + 12~36 wires x signal(2A)

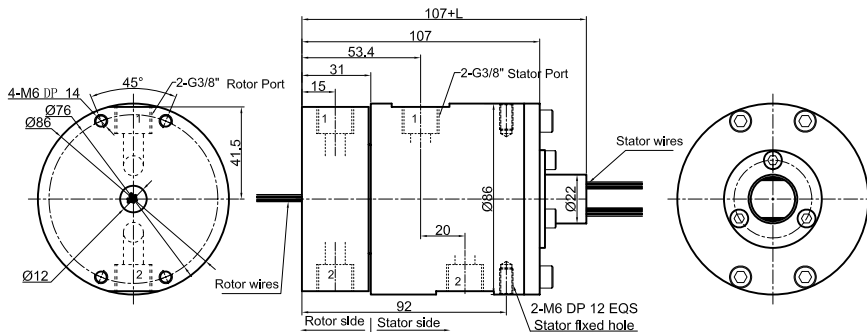

Part list

Model	Passages	Connection Size	Adaptive tube	Signal(2A)	L(mm)
MK23S-S12	2	G3/8"	10~12mm	12	22.5
MK23S-S18	2	G3/8"	10~12mm	18	29.5
MK23S-S24	2	G3/8"	10~12mm	24	40.1
MK23S-S36	2	G3/8"	10~12mm	36	53.8

MK23S-S56 drawing 2 in 2 out, connection size G3/8"

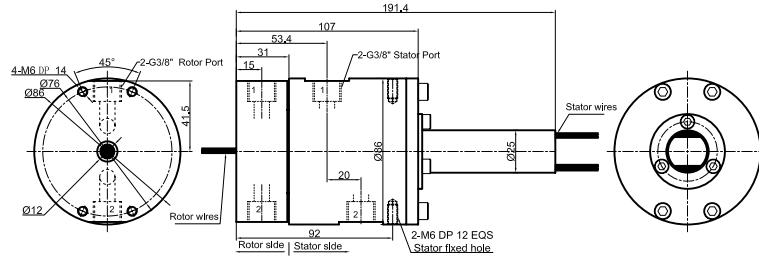

Part list

Model	Passages	Connection Size	Adaptive tube	Signal(2A)
MK23S-S56	2	G3/8"	10~12mm	56

MK23-PXX-SXX drawing 2 in 2 out, connection size G3/8" + signal(5A)/10A

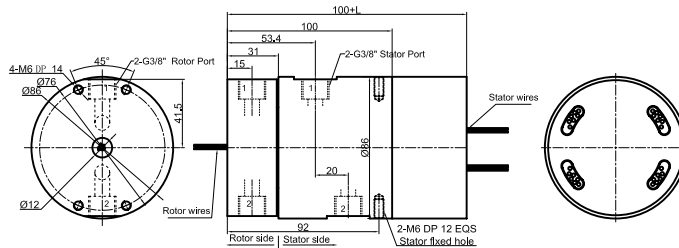

Part list

Model	Passages	Connection Size	Adaptive tube	10A	Signal(5A)	L(mm)
MK23-P0610	2	G3/8"	10~12mm	6	0	45.2
MK23-S06	2	G3/8"	10~12mm	0	6	45.2
MK23-P1210	2	G3/8"	10~12mm	12	0	65.6
MK23-P0610-S06	2	G3/8"	10~12mm	6	6	65.6
MK23-S12	2	G3/8"	10~12mm	0	12	65.6
MK23-P1810	2	G3/8"	10~12mm	18	0	86
MK23-P0610-S12	2	G3/8"	10~12mm	6	12	86
MK23-P1210-S06	2	G3/8"	10~12mm	12	6	86
MK23-S18	2	G3/8"	10~12mm	0	18	86
MK23-S24	2	G3/8"	10~12mm	0	24	106.4
MK23-P0610-S18	2	G3/8"	10~12mm	6	18	106.4
MK23-S30	2	G3/8"	10~12mm	0	30	126.8
MK23-S36	2	G3/8"	10~12mm	0	36	150.2

Note:10A and signal(5A) can be freely combined, please contact customer service for details.

Specifications

Rotary Union Specifications			Mechanical data	
Parameter	Value		Parameter	Value
Passage	2 in 2 out, G3/8"		Working life	Over 10 Million Revs
Max Pressure	1MPa(high pressure can be customized), Vacuum 0.01torr		Rated Rotating Speed	500RPM
Torque	Related to the connection size, please see the product selection table		Working Temperature	-30°C~80°C
Electrical Data			Operating Humidity	0~85% RH
Parameter	Value		Contact Material	Precious Metal
	Power	Signal	Housing Material	Aluminium Alloy
Rated Voltage	0~440VAC/VDC	0~440VAC/VDC	Protection Grade	IP51
Insulation Resistance	≥1000MΩ/500VDC	≥1000MΩ/500VDC		
Lead Wires	AWG16#Teflon/PVC	AWG22#Teflon/PVC		
Lead Length	Standard 300mm(adjustable on request)			
Dielectric Strength	500VAC@50Hz, 60s			
Electrical Noise	<0.01Ω			

MK41(4 passages Pneumatic Rotary Union Union--Can combine electric wires)



MK41 series is 4 passages Pneumatic Rotary Union(Can combine electric wires), with connection size G1/8", compact size, light weight, low torque, Also optional for transmitting power line, signal line, industrial bus, control line, Electromagnetic valve, induction line, etc.; Standard installation is flange mounting.

Media Types: compressed Air/Gas, vacuum, etc.

MK41 (rotary union only for pneumatic) drawing (4 in 4 out, connection size G1/8")

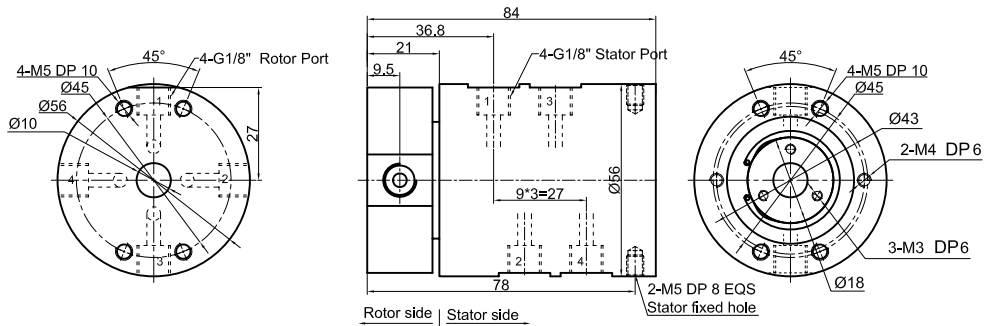

Part list

Model	Passages	Connection Size	Adaptive tube
MK41	4	G1/8"	6~8mm

MK41S-S12 drawing 4 in 4 out, connection size G1/8" + 12~36 wires x signal(2A)

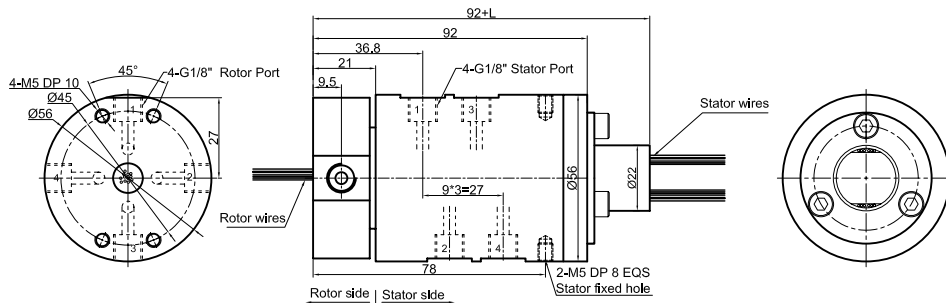

Part list

Model	Passages	Connection Size	Adaptive tube	Signal(2A)	L(mm)
MK41S-S12	4	G1/8"	6~8mm	12	22.5
MK41S-S18	4	G1/8"	6~8mm	18	29.5
MK41S-S24	4	G1/8"	6~8mm	24	40.1
MK41S-S36	4	G1/8"	6~8mm	36	53.8

MK41S-S56 drawing 4 in 4 out, connection size G1/8"

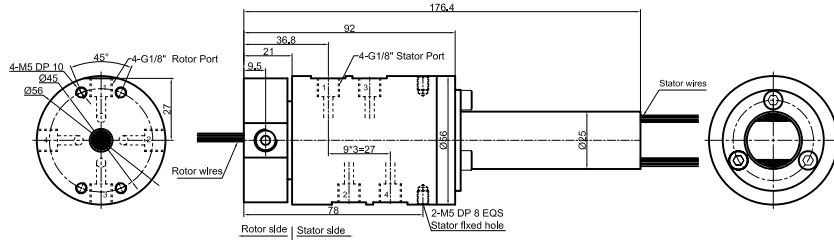

Part list

Model	Passages	Connection Size	Adaptive tube	Signal(2A)
MK41S-S56	4	G1/8"	6~8mm	56

MK41-PXX-SXX drawing 4 in 4 out, connection size G1/8" + signal(5A)/10A

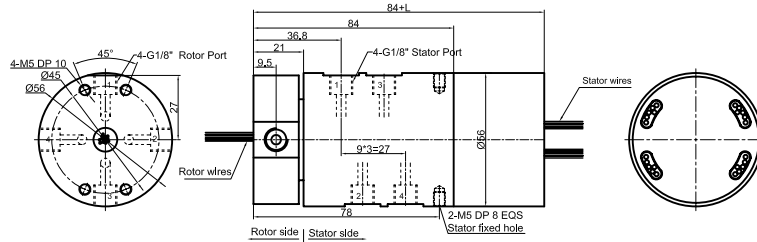

Part list

Model	Passages	Connection Size	Adaptive tube	10A	Signal(5A)	L(mm)
MK41-P0610	4	G1/8"	6~8mm	6	0	38
MK41-S06	4	G1/8"	6~8mm	0	6	38
MK41-P1210	4	G1/8"	6~8mm	12	0	54.8
MK41-P0610-S06	4	G1/8"	6~8mm	6	6	54.8
MK41-S12	4	G1/8"	6~8mm	0	12	54.8
MK41-P1810	4	G1/8"	6~8mm	18	0	71.5
MK41-P0610-S12	4	G1/8"	6~8mm	6	12	71.5
MK41-P1210-S06	4	G1/8"	6~8mm	12	6	71.5
MK41-S18	4	G1/8"	6~8mm	0	18	71.5
MK41-S24	4	G1/8"	6~8mm	0	24	88.4
MK41-P0610-S18	4	G1/8"	6~8mm	6	18	88.4
MK41-S30	4	G1/8"	6~8mm	0	30	105.2
MK41-S36	4	G1/8"	6~8mm	0	36	125

Note:10A and signal(5A) can be freely combined, please contact customer service for details.

Specifications

Rotary Union Specifications			Mechanical data	
Parameter	Value		Parameter	Value
Passage	4 in 4 out, G1/8"		Working life	Over 10 Million Revs
Max Pressure	1MPa(high pressure can be customized), Vacuum 0.01torr		Rated Rotating Speed	500RPM
Torque	Related to the connection size, please see the product selection table		Working Temperature	-30°C~80°C
Electrical Data			Operating Humidity	0~85% RH
Parameter	Value		Contact Material	Precious Metal
	Power	Signal	Housing Material	Aluminium Alloy
Rated Voltage	0~240VAC/VDC	0~240VAC/VDC	Protection Grade	IP51
Insulation Resistance	≥500MΩ/500VDC	≥500MΩ/500VDC		
Lead Wires	AWG17#Teflon/PVC	AWG22#Teflon/PVC		
Lead Length	Standard 300mm(adjustable on request)			
Dielectric Strength	500VAC@50Hz, 60s			
Electrical Noise	<0.01Ω			

MK43(4 passages Pneumatic Rotary Union--Can combine electric wires)



MK43 series is 4 passages Pneumatic Rotary Union(Can combine electric wires), with connection size G3/8", compact size, light weight, low torque, Also optional for transmitting power line, signal line, industrial bus, control line, Electromagnetic valve, induction line, etc.; Standard installation is flange mounting.

Media Types: compressed Air/Gas, vacuum, etc.

MK43 (rotary union only for pneumatic) drawing (4 in 4 out, connection size G3/8")

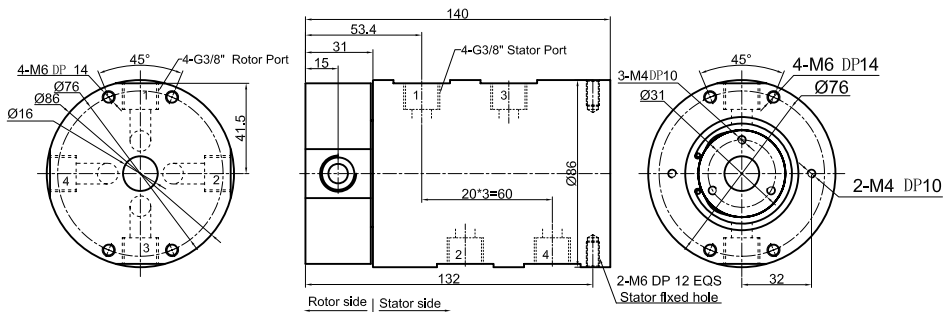

Part list

Model	Passages	Connection Size	Adaptive tube
MK43	4	G3/8"	10~12mm

MK43S-S12 drawing 4 in 4 out, connection size G3/8" + 12~36 wires x signal(2A)

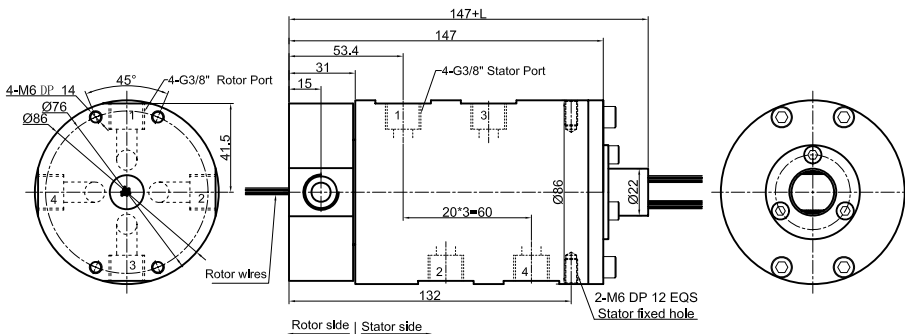

Part list

Model	Passages	Connection Size	Adaptive tube	Signal(2A)	L(mm)
MK43S-S12	4	G3/8"	10~12mm	12	22.5
MK43S-S18	4	G3/8"	10~12mm	18	29.5
MK43S-S24	4	G3/8"	10~12mm	24	40.1
MK43S-S36	4	G3/8"	10~12mm	36	53.8

MK43S-S56 drawing 4 in 4 out, connection size G3/8"

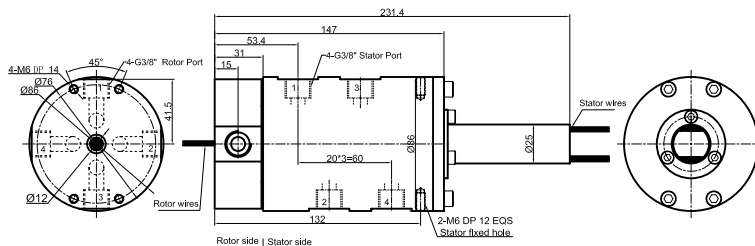

Part list

Model	Passages	Connection Size	Adaptive tube	Signal(2A)
MK43S-S56	4	G3/8"	10~12mm	56

MK43-PXX-SXX drawing 4 in 4 out, connection size G3/8" + signal(5A)/10A

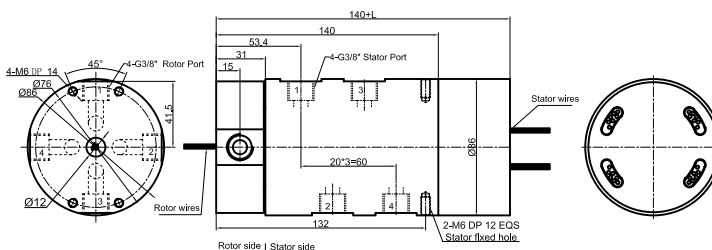

Part list

Model	Passages	Connection Size	Adaptive tube	10A	Signal(5A)	L(mm)
MK43-P0610	4	G3/8"	10~12mm	6	0	45.2
MK43-S06	4	G3/8"	10~12mm	0	6	45.2
MK43-P1210	4	G3/8"	10~12mm	12	0	65.6
MK43-P0610-S06	4	G3/8"	10~12mm	6	6	65.6
MK43-S12	4	G3/8"	10~12mm	0	12	65.6
MK43-P1810	4	G3/8"	10~12mm	18	0	86
MK43-P0610-S12	4	G3/8"	10~12mm	6	12	86
MK43-P1210-S06	4	G3/8"	10~12mm	12	6	86
MK43-S18	4	G3/8"	10~12mm	0	18	86
MK43-S24	4	G3/8"	10~12mm	0	24	106.4
MK43-P0610-S18	4	G3/8"	10~12mm	6	18	106.4
MK43-S30	4	G3/8"	10~12mm	0	30	126.8
MK43-S36	4	G3/8"	10~12mm	0	36	150.2

Note:10A and signal(5A) can be freely combined, please contact customer service for details.

Specifications

Rotary Union Specifications			Mechanical data	
Parameter	Value		Parameter	Value
Passage	4 in 4 out, G3/8"		Working life	Over 10 Million Revs
Max Pressure	1MPa(high pressure can be customized), Vacuum 0.01torr		Rated Rotating Speed	500RPM
Torque	Related to the connection size, please see the product selection table		Working Temperature	-30°C~80°C
Electrical Data			Operating Humidity	0~85% RH
Parameter	Value		Contact Material	Precious Metal
	Power	Signal	Housing Material	Aluminium Alloy
Rated Voltage	0~440VAC/VDC	0~440VAC/VDC	Protection Grade	IP51
Insulation Resistance	≥1000MΩ/500VDC	≥1000MΩ/500VDC		
Lead Wires	AWG16#Teflon/PVC	AWG22#Teflon/PVC		
Lead Length	Standard 300mm(adjustable on request)			
Dielectric Strength	500VAC@50Hz, 60s			
Electrical Noise	<0.01Ω			

MK81(8 passages Pneumatic Rotary Union--Can combine electric wires)



Mk81 series is 8 passages Pneumatic Rotary Union(Can combine electric wires), with connection size G1/8", compact size, light weight, low torque, Also optional for transmitting power line, signal line, industrial bus, control line, Electromagnetic valve, induction line, etc.; Standard installation is flange mounting.
Media Types: compressed Air/Gas, vacuum, etc.

MK81 (rotary union only for pneumatic) drawing (8 in 8 out, connection size G1/8")

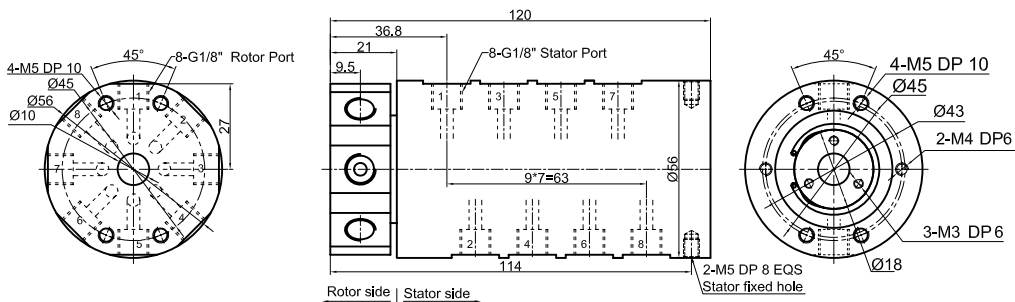

Part list

Model	Passages	Connection Size	Adaptive tube
MK81	8	G1/8"	6~8mm

MK81S-S12 drawing 8 in 8 out, connection size G1/8" + 12~36 wires x signal(2A)

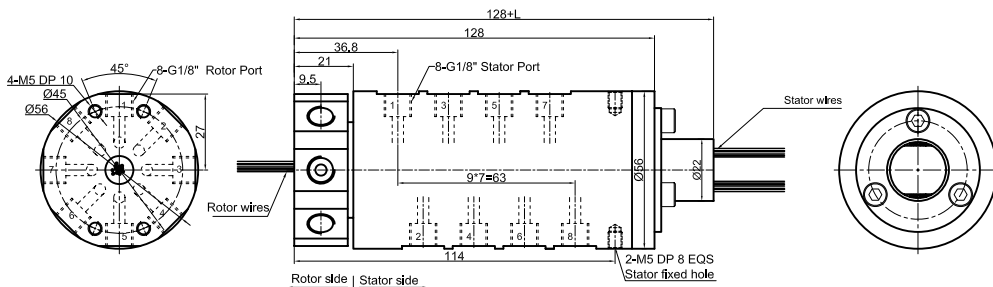

Part list

Model	Passages	Connection Size	Adaptive tube	Signal(2A)	L(mm)
MK81S-S12	8	G1/8"	6~8mm	12	22.5
MK81S-S18	8	G1/8"	6~8mm	18	29.5
MK81S-S24	8	G1/8"	6~8mm	24	40.1
MK81S-S36	8	G1/8"	6~8mm	36	53.8

MK81S-S56 drawing 8 in 8 out, connection size G1/8"

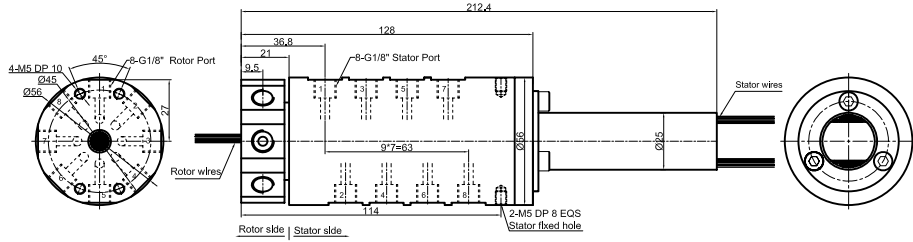

Part list

Model	Passages	Connection Size	Adaptive tube	Signal(2A)
MK81S-S56	8	G1/8"	6~8mm	56

MK81-PXX-SXX drawing 8 in 8 out, connection size G1/8" + signal(5A)/10A

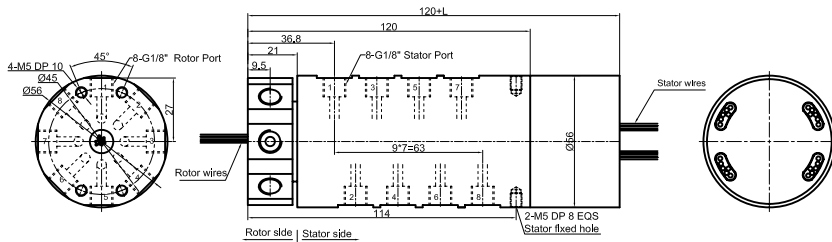

Part list

Model	Passages	Connection Size	Adaptive tube	10A	Signal(5A)	L(mm)
MK81-P0610	8	G1/8"	6~8mm	6	0	38
MK81-S06	8	G1/8"	6~8mm	0	6	38
MK81-P1210	8	G1/8"	6~8mm	12	0	54.8
MK81-P0610-S06	8	G1/8"	6~8mm	6	6	54.8
MK81-S12	8	G1/8"	6~8mm	0	12	54.8
MK81-P1810	8	G1/8"	6~8mm	18	0	71.5
MK81-P0610-S12	8	G1/8"	6~8mm	6	12	71.5
MK81-P1210-S06	8	G1/8"	6~8mm	12	6	71.5
MK81-S18	8	G1/8"	6~8mm	0	18	71.5
MK81-S24	8	G1/8"	6~8mm	0	24	88.4
MK81-P0610-S18	8	G1/8"	6~8mm	6	18	88.4
MK81-S30	8	G1/8"	6~8mm	0	30	105.2
MK81-S36	8	G1/8"	6~8mm	0	36	125

Note:10A and signal(5A) can be freely combined, please contact customer service for details.

Specifications

Rotary Union Specifications			Mechanical data	
Parameter	Value		Parameter	Value
Passage	8 in 8 out, G1/8"		Working life	Over 10 Million Revs
Max Pressure	1MPa(high pressure can be customized), Vacuum 0.01torr		Rated Rotating Speed	500RPM
Torque	Related to the connection size, please see the product selection table		Working Temperature	-30°C~80°C
Electrical Data			Operating Humidity	0~85% RH
Parameter	Value		Contact Material	Precious Metal
	Power	Signal	Housing Material	Aluminium Alloy
Rated Voltage	0~240VAC/VDC	0~240VAC/VDC	Protection Grade	IP51
Insulation Resistance	≥500MΩ/500VDC	≥500MΩ/500VDC		
Lead Wires	AWG17#Teflon/PVC	AWG22#Teflon/PVC		
Lead Length	Standard 300mm(adjustable on request)			
Dielectric Strength	500VAC@50Hz, 60s			
Electrical Noise	<0.01Ω			

MK83(8 passages Pneumatic Rotary Union Union--Can combine electric wires)



MK83 series is 8 passages Pneumatic Rotary Union(Can combine electric wires), with connection size G3/8", compact size, light weight, low torque, Also optional for transmitting power line, signal line, industrial bus, control line, Electromagnetic valve, induction line, etc.; Standard installation is flange mounting.
Media Types: compressed Air/Gas, vacuum, etc.

MK83 (rotary union only for pneumatic) drawing (8 in 8 out, connection size G3/8")

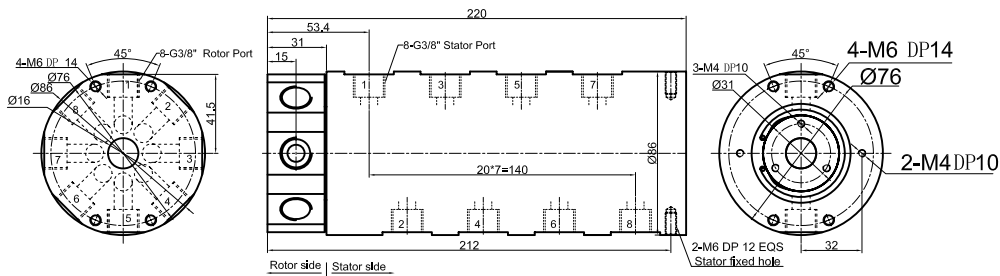

Part list

Model	Passages	Connection Size	Adaptive tube
MK83	8	G3/8"	10~12mm

MK83S-S12 drawing 8 in 8 out, connection size G3/8" + 12~36 wires x signal(2A)

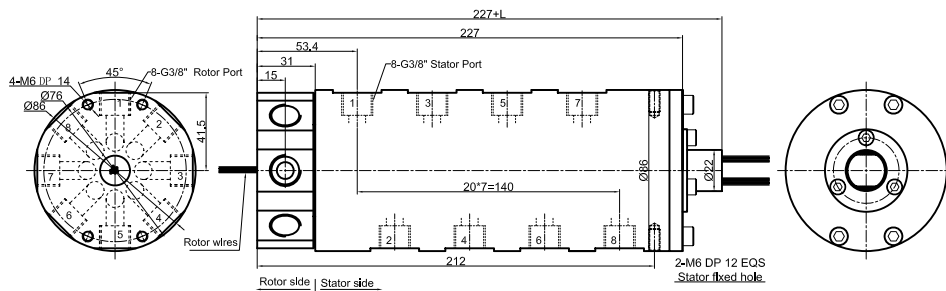

Part list

Model	Passages	Connection Size	Adaptive tube	Signal(2A)	L(mm)
MK83S-S12	8	G3/8"	10~12mm	12	22.5
MK83S-S18	8	G3/8"	10~12mm	18	29.5
MK83S-S24	8	G3/8"	10~12mm	24	40.1
MK83S-S36	8	G3/8"	10~12mm	36	53.8

MK83S-S56 drawing 8 in 8 out, connection size G3/8"

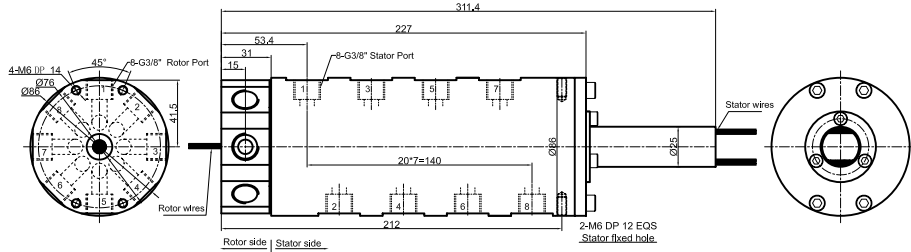

Part list

Model	Passages	Connection Size	Adaptive tube	Signal(2A)
MK83S-S56	8	G3/8"	10~12mm	56

MK83-PXX-SXX drawing 8 in 8 out, connection size G3/8" + signal(5A)/10A

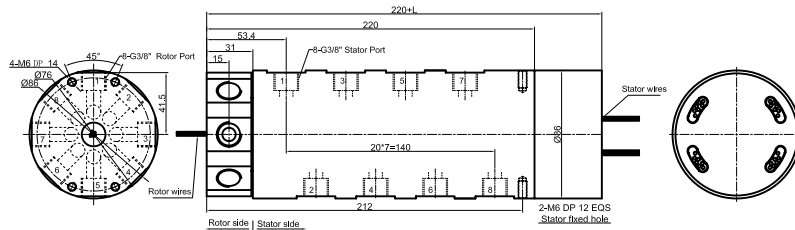

Part list

Model	Passages	Connection Size	Adaptive tube	10A	Signal(5A)	L(mm)
MK83-P0610	8	G3/8"	10~12mm	6	0	45.2
MK83-S06	8	G3/8"	10~12mm	0	6	45.2
MK83-P1210	8	G3/8"	10~12mm	12	0	65.6
MK83-P0610-S06	8	G3/8"	10~12mm	6	6	65.6
MK83-S12	8	G3/8"	10~12mm	0	12	65.6
MK83-P1810	8	G3/8"	10~12mm	18	0	86
MK83-P0610-S12	8	G3/8"	10~12mm	6	12	86
MK83-P1210-S06	8	G3/8"	10~12mm	12	6	86
MK83-S18	8	G3/8"	10~12mm	0	18	86
MK83-S24	8	G3/8"	10~12mm	0	24	106.4
MK83-P0610-S18	8	G3/8"	10~12mm	6	18	106.4
MK83-S30	8	G3/8"	10~12mm	0	30	126.8
MK83-S36	8	G3/8"	10~12mm	0	36	150.2

Note:10A and signal(5A) can be freely combined, please contact customer service for details.

Specifications

Rotary Union Specifications			Mechanical data	
Parameter	Value		Parameter	Value
Passage	8 in 8 out, G3/8"		Working life	Over 10 Million Revs
Max Pressure	1MPa(high pressure can be customized), Vacuum 0.01torr		Rated Rotating Speed	500RPM
Torque	Related to the connection size, please see the product selection table		Working Temperature	-30°C~80°C
Electrical Data			Operating Humidity	0~85% RH
Parameter	Value		Contact Material	Precious Metal
	Power	Signal	Housing Material	Aluminium Alloy
Rated Voltage	0~440VAC/VDC	0~440VAC/VDC	Protection Grade	IP51
Insulation Resistance	≥1000MΩ/500VDC	≥1000MΩ/500VDC		
Lead Wires	AWG16#Teflon/PVC	AWG22#Teflon/PVC		
Lead Length	Standard 300mm(adjustable on request)			
Dielectric Strength	500VAC@50Hz, 60s			
Electrical Noise	<0.01Ω			

MK121(12 passages Pneumatic Rotary Union Union--Can combine electric wires)

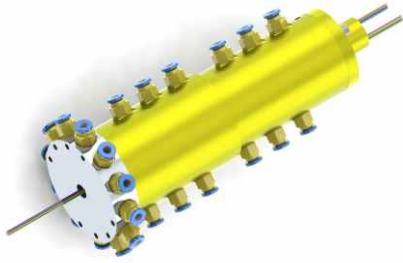

MK121 series is 12 passages Pneumatic Rotary Union(Can combine electric wires), with connection size G1/8", compact size, light weight, low torque, Also optional for transmitting power line, signal line, industrial bus, control line, Electromagnetic valve, induction line, etc.; Standard installation is flange mounting.
Media Types: compressed Air/Gas, vacuum, etc.

MK121 (rotary union only for pneumatic) drawing (12 in 12 out, connection size G1/8")

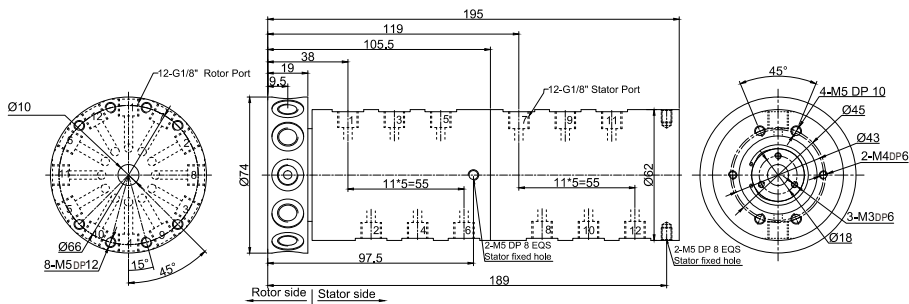

Part list

Model	Passages	Connection Size	Adaptive tube
MK121	12	G1/8"	6~8mm

MK121S-S12 drawing 12 in 12 out, connection size G1/8" + 12~36 wires x signal(2A)

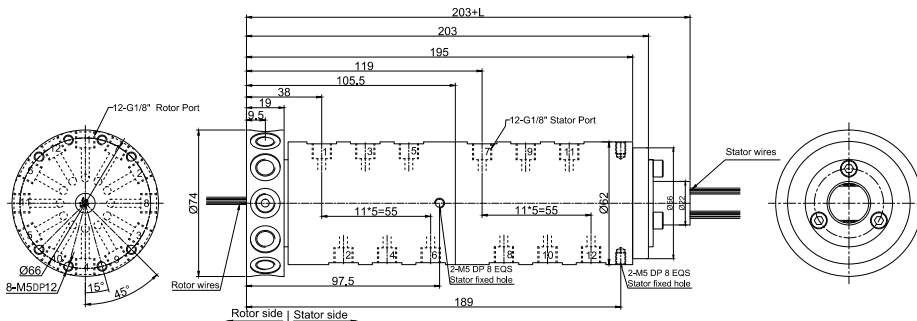

Part list

Model	Passages	Connection Size	Adaptive tube	Signal(2A)	L(mm)
MK121S-S12	12	G1/8"	6~8mm	12	22.5
MK121S-S18	12	G1/8"	6~8mm	18	29.5
MK121S-S24	12	G1/8"	6~8mm	24	40.1
MK121S-S36	12	G1/8"	6~8mm	36	53.8

MK121S-S56 drawing 12 in 12 out, connection size G1/8"

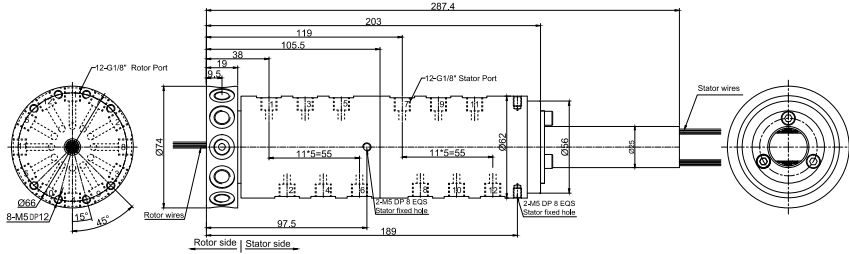

Part list

Model	Passages	Connection Size	Adaptive tube	Signal(2A)
MK121S-S56	12	G1/8"	6~8mm	56

MK121-PXX-SXX drawing 12 in 12 out, connection size G1/8" + signal(5A)/10A

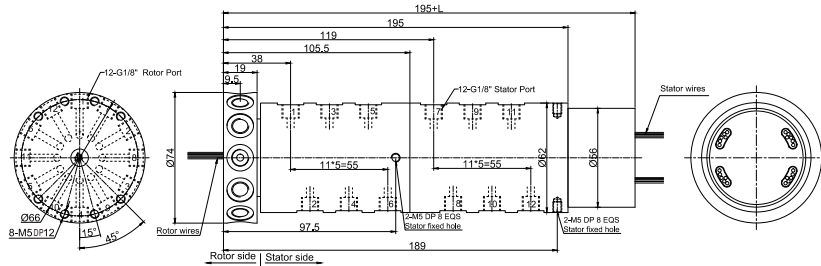

Part list

Model	Passages	Connection Size	Adaptive tube	10A	Signal(5A)	L(mm)
MK121-P0610	12	G1/8"	6~8mm	6	0	38
MK121-S06	12	G1/8"	6~8mm	0	6	38
MK121-P1210	12	G1/8"	6~8mm	12	0	54.8
MK121-P0610-S06	12	G1/8"	6~8mm	6	6	54.8
MK121-S12	12	G1/8"	6~8mm	0	12	54.8
MK121-P1810	12	G1/8"	6~8mm	18	0	71.5
MK121-P0610-S12	12	G1/8"	6~8mm	6	12	71.5
MK121-P1210-S06	12	G1/8"	6~8mm	12	6	71.5
MK121-S18	12	G1/8"	6~8mm	0	18	71.5
MK121-S24	12	G1/8"	6~8mm	0	24	88.4
MK121-P0610-S18	12	G1/8"	6~8mm	6	18	88.4
MK121-S30	12	G1/8"	6~8mm	0	30	105.2
MK121-S36	12	G1/8"	6~8mm	0	36	125

Note:10A and signal(5A) can be freely combined, please contact customer service for details.

Specifications

Rotary Union Specifications			Mechanical data	
Parameter	Value		Parameter	Value
Passage	12 in 12 out, G1/8"		Working life	Over 10 Million Revs
Max Pressure	1MPa(high pressure can be customized), Vacuum 0.01torr		Rated Rotating Speed	500RPM
Torque	Related to the connection size, please see the product selection table		Working Temperature	-30°C~80°C
Electrical Data			Operating Humidity	0~85% RH
Parameter	Value		Contact Material	Precious Metal
	Power	Signal	Housing Material	Aluminium Alloy
Rated Voltage	0~240VAC/VDC	0~240VAC/VDC	Protection Grade	IP51
Insulation Resistance	≥500MΩ/500VDC	≥500MΩ/500VDC		
Lead Wires	AWG17#Teflon/PVC	AWG22#Teflon/PVC		
Lead Length	Standard 300mm(adjustable on request)			
Dielectric Strength	500VAC@50Hz, 60s			
Electrical Noise	<0.01Ω			

MK123(12 passages Pneumatic Rotary Union Union--Can combine electric wires)

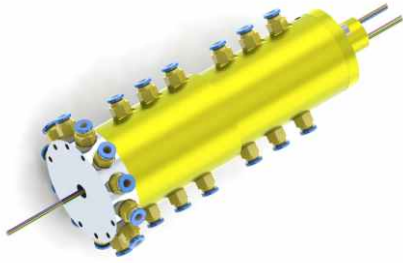

MK123 series is 12 passages Pneumatic Rotary Union(Can combine electric wires), with connection size G3/8", compact size, light weight, low torque, Also optional for transmitting power line, signal line, industrial bus, control line, Electromagnetic valve, induction line, etc.; Standard installation is flange mounting.
Media Types: compressed Air/Gas, vacuum, etc.

MK123 (rotary union only for pneumatic) drawing (12 in 12 out, connection size G3/8")

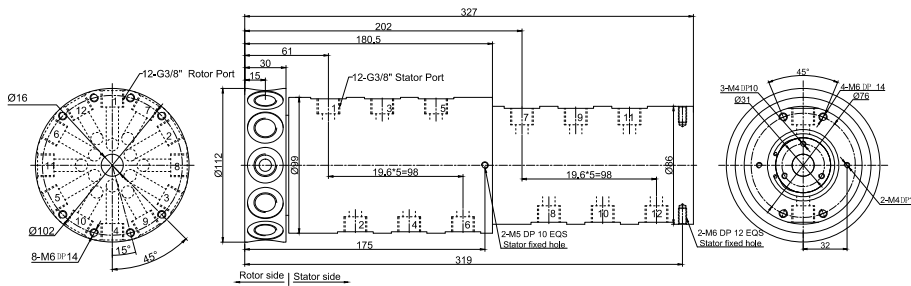

Part list

Model	Passages	Connection Size	Adaptive tube
MK123	12	G3/8"	10~12mm

MK123S-S12 drawing 12 in 12 out, connection size G3/8" + 12~36 wires x signal(2A)

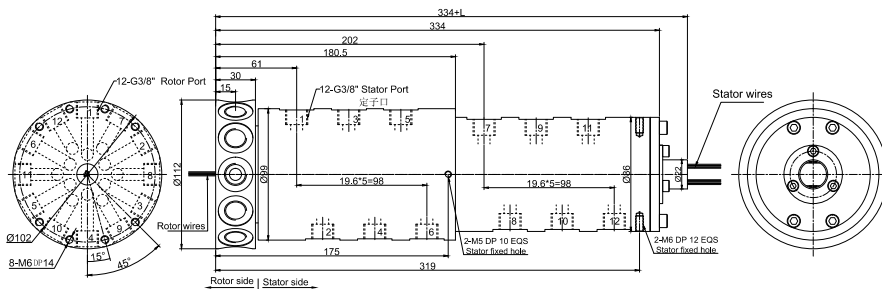

Part list

Model	Passages	Connection Size	Adaptive tube	Signal(2A)	L(mm)
MK123S-S12	12	G3/8"	10~12mm	12	22.5
MK123S-S18	12	G3/8"	10~12mm	18	29.5
MK123S-S24	12	G3/8"	10~12mm	24	40.1
MK123S-S36	12	G3/8"	10~12mm	36	53.8

MK123S-S56 drawing 12 in 12 out, connection size G3/8"

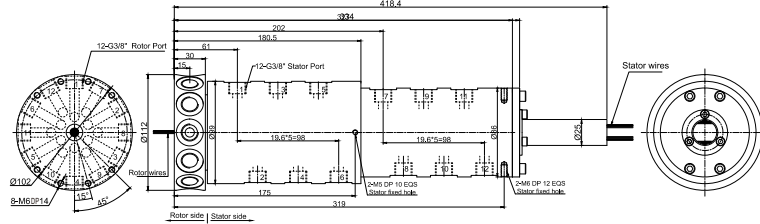

Part list

Model	Passages	Connection Size	Adaptive tube	Signal(2A)
MK123S-S56	12	G3/8"	10~12mm	56

MK123-PXX-SXX drawing 12 in 12 out, connection size G3/8"+signal(5A)/10A

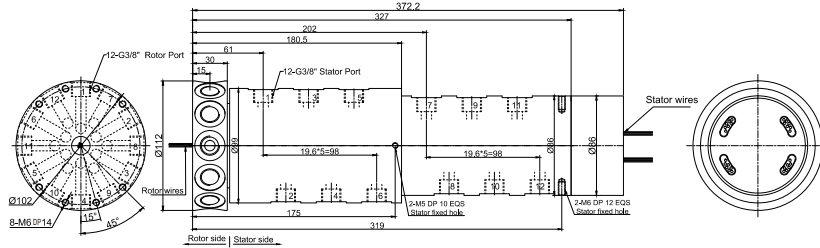

Part list

Model	Passages	Connection Size	Adaptive tube	10A	Signal(5A)	L(mm)
MK123-P0610	12	G3/8"	10~12mm	6	0	45.2
MK123-S06	12	G3/8"	10~12mm	0	6	45.2
MK123-P1210	12	G3/8"	10~12mm	12	0	65.6
MK123-P0610-S06	12	G3/8"	10~12mm	6	6	65.6
MK123-S12	12	G3/8"	10~12mm	0	12	65.6
MK123-P1810	12	G3/8"	10~12mm	18	0	86
MK123-P0610-S12	12	G3/8"	10~12mm	6	12	86
MK123-P1210-S06	12	G3/8"	10~12mm	12	6	86
MK123-S18	12	G3/8"	10~12mm	0	18	86
MK123-S24	12	G3/8"	10~12mm	0	24	106.4
MK123-P0610-S18	12	G3/8"	10~12mm	6	18	106.4
MK123-S30	12	G3/8"	10~12mm	0	30	126.8
MK123-S36	12	G3/8"	10~12mm	0	36	150.2

Note:10A and signal(5A) can be freely combined, please contact customer service for details.

Specifications

Rotary Union Specifications			Mechanical data	
Parameter	Value		Parameter	Value
Passage	12 in 12 out, G3/8"		Working life	Over 10 Million Revs
Max Pressure	1MPa(high pressure can be customized), Vacuum 0.01torr		Rated Rotating Speed	500RPM
Torque	Related to the connection size, please see the product selection table		Working Temperature	-30°C~80°C
Electrical Data			Operating Humidity	0~85% RH
Parameter	Value		Contact Material	Precious Metal
	Power	Signal	Housing Material	Aluminium Alloy
Rated Voltage	0~440VAC/VDC	0~440VAC/VDC	Protection Grade	IP51
Insulation Resistance	≥1000MΩ/500VDC	≥1000MΩ/500VDC		
Lead Wires	AWG16#Teflon/PVC	AWG22#Teflon/PVC		
Lead Length	Standard 300mm(adjustable on request)			
Dielectric Strength	500VAC@50Hz , 60s			
Electrical Noise	<0.01Ω			

Mk161(16 passages Pneumatic Rotary Union--Can combine electric wires)

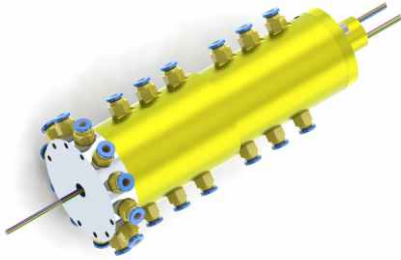

Mk161 series is 16 passages Pneumatic Rotary Union(Can combine electric wires), with connection size G1/8", compact size, light weight, low torque, Also optional for transmitting power line, signal line, industrial bus, control line, Electromagnetic valve, induction line, etc.; Standard installation is flange mounting.
Media Types: compressed Air/Gas, vacuum, etc.

Mk161 (rotary union only for pneumatic) drawing (16 in 16 out, connection size G1/8")

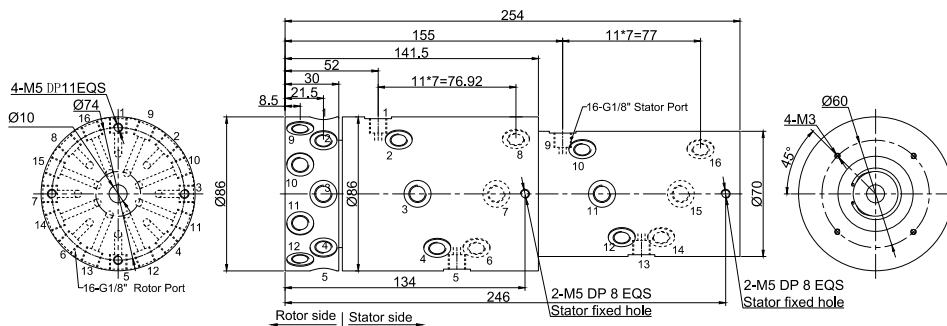

Part list

Model	Passages	Connection Size	Adaptive tube
Mk161	16	G1/8"	6~8mm

Mk161S-S12 drawing 16 in 16 out, connection size G1/8" + 12~36 wires x signal(2A)

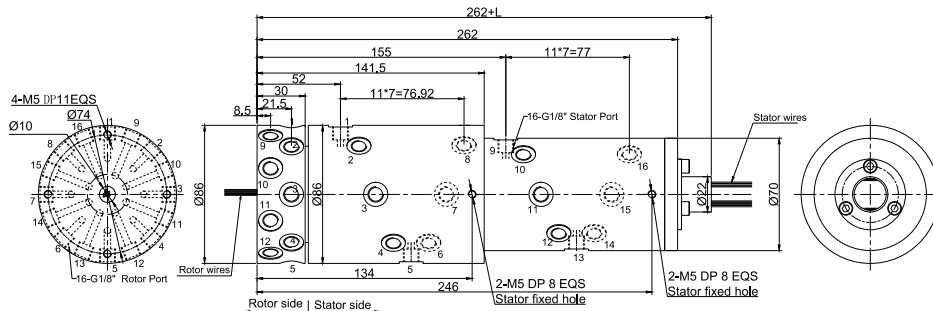

Part list

Model	Passages	Connection Size	Adaptive tube	Signal(2A)	L(mm)
Mk161S-S12	16	G1/8"	6~8mm	12	22.5
Mk161S-S18	16	G1/8"	6~8mm	18	29.5
Mk161S-S24	16	G1/8"	6~8mm	24	40.1
Mk161S-S36	16	G1/8"	6~8mm	36	53.8

MK161S-S56 drawing 16 in 16 out, connection size G1/8"

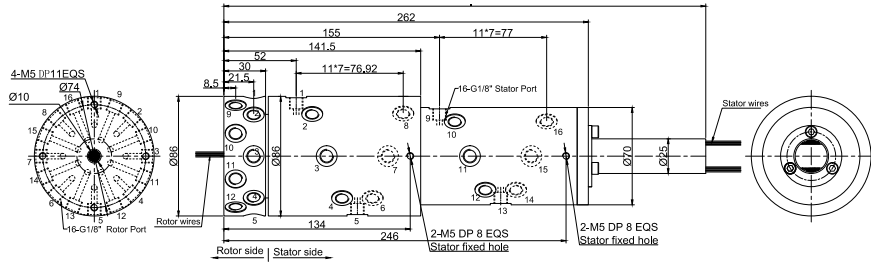

Part list

Model	Passages	Connection Size	Adaptive tube	Signal(2A)
MK161S-S56	16	G1/8"	6~8mm	56

MK161-PXX-SXX drawing 16 in 16 out, connection size G1/8" + signal(5A)/10A

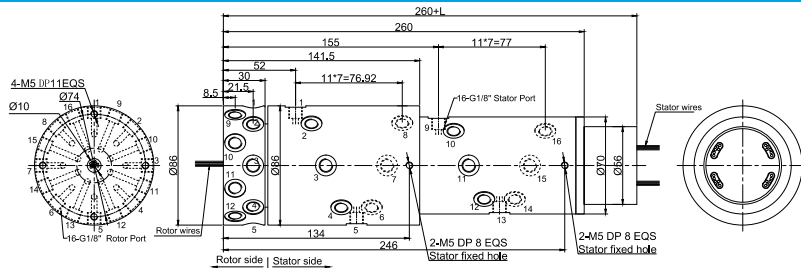

Part list

Model	Passages	Connection Size	Adaptive tube	10A	Signal(5A)	L(mm)
MK161-P0610	16	G1/8"	6~8mm	6	0	38
MK161-S06	16	G1/8"	6~8mm	0	6	38
MK161-P1210	16	G1/8"	6~8mm	12	0	54.8
MK161-P0610-S06	16	G1/8"	6~8mm	6	6	54.8
MK161-S12	16	G1/8"	6~8mm	0	12	54.8
MK161-P1810	16	G1/8"	6~8mm	18	0	71.5
MK161-P0610-S12	16	G1/8"	6~8mm	6	12	71.5
MK161-P1210-S06	16	G1/8"	6~8mm	12	6	71.5
MK161-S18	16	G1/8"	6~8mm	0	18	71.5
MK161-S24	16	G1/8"	6~8mm	0	24	88.4
MK161-P0610-S18	16	G1/8"	6~8mm	6	18	88.4
MK161-S30	16	G1/8"	6~8mm	0	30	105.2
MK161-S36	16	G1/8"	6~8mm	0	36	125

Note:10A and signal(5A) can be freely combined, please contact customer service for details.

Specifications

Rotary Union Specifications			Mechanical data	
Parameter	Value		Parameter	Value
Passage	16 in 16 out, G1/8"		Working life	Over 10 Million Revs
Max Pressure	1MPa(high pressure can be customized), Vacuum 0.01torr		Rated Rotating Speed	500RPM
Torque	Related to the connection size, please see the product selection table		Working Temperature	-30°C~80°C
Electrical Data			Operating Humidity	0~85% RH
Parameter	Value		Contact Material	Precious Metal
	Power	Signal	Housing Material	Aluminium Alloy
Rated Voltage	0~240VAC/VDC	0~240VAC/VDC	Protection Grade	IP51
Insulation Resistance	≥500MΩ/500VDC	≥500MΩ/500VDC		
Lead Wires	AWG17#Teflon/PVC	AWG22#Teflon/PVC		
Lead Length	Standard 300mm(adjustable on request)			
Dielectric Strength	500VAC@50Hz, 60s			
Electrical Noise	<0.01Ω			

MK241(24 passages Pneumatic Rotary Union Union--Can combine electric wires)

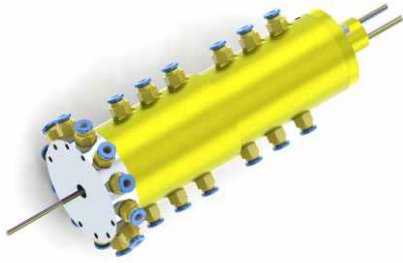

MK241 series is 24 passages Pneumatic Rotary Union(Can combine electric wires), with connection size G1/8", compact size, light weight, low torque, Also optional for transmitting power line, signal line, industrial bus, control line, Electromagnetic valve, induction line, etc.; Standard installation is flange mounting.
Media Types: compressed Air/Gas, vacuum, etc.

MK241 (rotary union only for pneumatic) drawing (24 in 24 out, connection size G1/8")

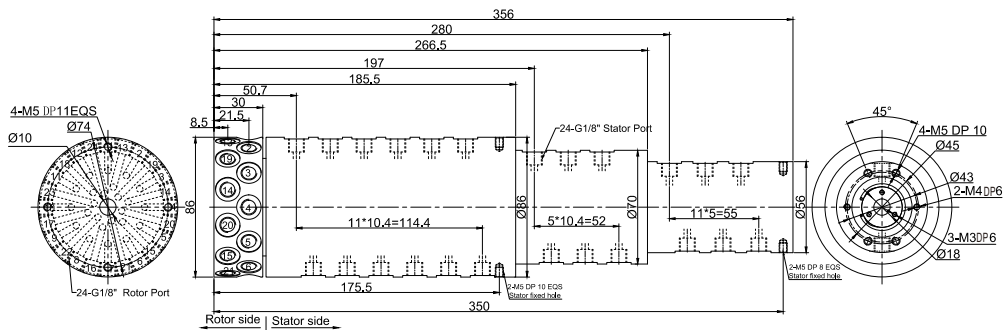

Part list

Model	Passages	Connection Size	Adaptive tube
MK241	24	G1/8"	6~8mm

MK241S-S12 drawing 24 in 24 out, connection size G1/8" + 12~36 wires x signal(2A)

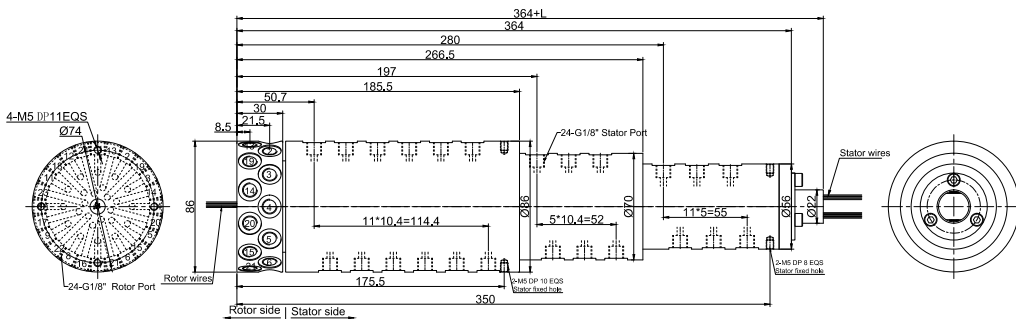

Part list

Model	Passages	Connection Size	Adaptive tube	Signal(2A)	L(mm)
MK241S-S12	24	G1/8"	6~8mm	12	22.5
MK241S-S18	24	G1/8"	6~8mm	18	29.5
MK241S-S24	24	G1/8"	6~8mm	24	40.1
MK241S-S36	24	G1/8"	6~8mm	36	53.8

MK241S-S56 drawing 24 in 24 out, connection size G1/8"

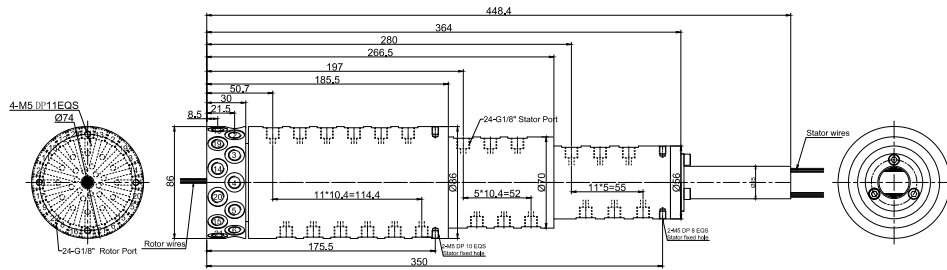

Part list

Model	Passages	Connection Size	Adaptive tube	Signal(2A)
MK241S-S56	24	G1/8"	6~8mm	56

MK241-PXX-SXX drawing 24 in 24 out, connection size G1/8" + signal(5A)/10A

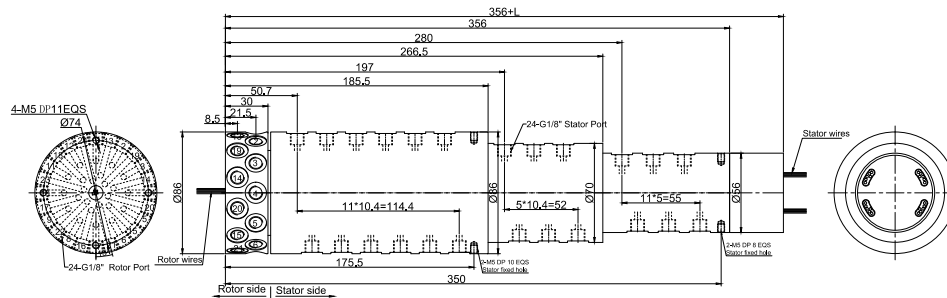

Part list

Model	Passages	Connection Size	Adaptive tube	10A	Signal(5A)	L(mm)
MK241-P0610	24	G1/8"	6~8mm	6	0	38
MK241-S06	24	G1/8"	6~8mm	0	6	38
MK241-P1210	24	G1/8"	6~8mm	12	0	54.8
MK241-P0610-S06	24	G1/8"	6~8mm	6	6	54.8
MK241-S12	24	G1/8"	6~8mm	0	12	54.8
MK241-P1810	24	G1/8"	6~8mm	18	0	71.5
MK241-P0610-S12	24	G1/8"	6~8mm	6	12	71.5
MK241-P1210-S06	24	G1/8"	6~8mm	12	6	71.5
MK241-S18	24	G1/8"	6~8mm	0	18	71.5
MK241-S24	24	G1/8"	6~8mm	0	24	88.4
MK241-P0610-S18	24	G1/8"	6~8mm	6	18	88.4
MK241-S30	24	G1/8"	6~8mm	0	30	105.2
MK241-S36	24	G1/8"	6~8mm	0	36	125

Note: 10A and signal(5A) can be freely combined, please contact customer service for details.

Specifications

Rotary Union Specifications			Mechanical data	
Parameter	Value		Parameter	Value
Passage	24 in 24 out, G1/8"		Working life	Over 10 Million Revs
Max Pressure	1MPa(high pressure can be customized), Vacuum 0.01torr		Rated Rotating Speed	500RPM
Torque	Related to the connection size, please see the product selection table		Working Temperature	-30°C~80°C
Electrical Data			Operating Humidity	0~85% RH
Parameter	Value		Contact Material	Precious Metal
	Power	Signal	Housing Material	Aluminium Alloy
Rated Voltage	0~240VAC/VDC	0~240VAC/VDC	Protection Grade	IP51
Insulation Resistance	≥500MΩ/500VDC	≥500MΩ/500VDC		
Lead Wires	AWG17#Teflon/PVC	AWG22#Teflon/PVC		
Lead Length	Standard 300mm(adjustable on request)			
Dielectric Strength	500VAC@50Hz , 60s			
Electrical Noise	<0.01Ω			

Product Quality Level Table

Products Level Code	Max Rotating Speed	Working Life	Contact Material
Common Quality Level	250RPM	20 Million Revs	Previous Metal
Industrial Quality Level	600RPM	80 Million Revs	Gold-gold
High-end Quality Level	1000RPM	150 Million Revs	Gold Alloy

Rings lead color code

Rings	1	2	3	4	5	6	7	8	9	10	11	12
Color	Black	Red	Yellow	Green	Blue	White	Black	Red	Yellow	Green	Blue	White

Note: 6 wires for one group color, from 7-12, repeat the same color as 1...6, indicate with number code pipe.

Options for Custom Slip Ring

Note: Below special demands can be customized. The delivery date will be extended about 3 to 15 days;also the cost will be increased about 5% to 50%. Most of our basic parts are standard and modular,which can save the cost and lead time.

1. Inner bore size, cable exit way and cable length for both rotor and stator can be customized.
2. Because of the structure limitation, length/height/OD can be customized on your request.
3. Max support 200 rings of power/signal.
4. Aviation plug, terminal and heat-shrink tube are optional.
5. Combined slip ring for Yaskawa, Panasonic and Siemens servo control signal, power line and encoder line.
6. Support mixed high speed data transmission(including Ethernet, USB, RS232, RS485, Profibus, CanBUS, CANOPEN, DeviceNET, CC-LINK, ProfiNET,EtherCAT, etc).
7. Can combine temperature control signal with thermocouple signal.
8. Special environment can be customized, such as quakeproof, high temperature, etc.
9. Combined Pneumatic/hydraulic joint with electric slip ring.
10. High temperature can up to 500 degree centigrade.
11. High voltage can up to 110KV.
12. Rotating speed can up to 10000RPM.
13. Maximum current can up to 5000(A) amperes.
14. Military Grade.
15. Optional for underwater IP65, IP68.
16. Optional for stainless steel housing.

Technical support: technical@moflon.com