

GT80158series

Standard series of integral precision conductive slip rings with outer diameter of 158mm and through hole diameter of 80mm (applicable to $\leq 80\text{mm}$).

*Note: if the inner hole of $< 80\text{mm}$ is needed, it can be solved by adding inner sleeve.

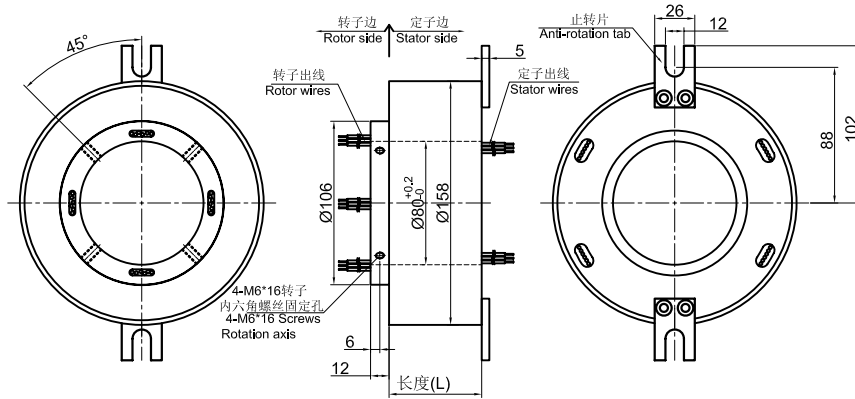

Part# Explanation

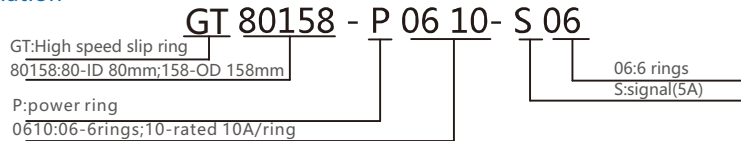

Part# List

Gt80158Series Parts# List							
Part#	10A	Signal/5A	Length-L (mm)	Part#	10A	Signal/5A	Length-L (mm)
GT80158-S06	0	06	65.6	GT80158-P1810-S12	18	12	161.8
GT80158-P0210-S04	02	04	65.6	GT80158-P2410-S06	24	06	161.8
GT80158-P0410-S02	04	02	65.6	GT80158-P3010	30	0	161.8
GT80158-P0610	06	0	65.6	GT80158-S36	0	36	184.6
GT80158-S12	0	12	88.4	GT80158-P0610-S30	06	30	184.6
GT80158-P0210-S10	02	10	88.4	GT80158-P1210-S24	12	24	184.6
GT80158-P0410-S08	04	08	88.4	GT80158-P1810-S18	18	18	184.6
GT80158-P0610-S06	06	06	88.4	GT80158-P2410-S12	24	12	184.6
GT80158-P0810-S04	08	04	88.4	GT80158-P3610	36	0	184.6
GT80158-P1010-S02	10	02	88.4	GT80158-S48	0	48	230.2
GT80158-P1210	12	0	88.4	GT80158-P0610-S42	06	42	230.2
GT80158-S18	0	18	111.2	GT80158-P1210-S36	12	36	230.2
GT80158-P0210-S16	02	16	111.2	GT80158-P1810-S30	18	30	230.2
GT80158-P0410-S14	04	14	111.2	GT80158-P2410-S24	24	24	230.2
GT80158-P0610-S12	06	12	111.2	GT80158-S60	0	60	280.8
GT80158-P0810-S10	08	10	111.2	GT80158-P0610-S54	06	54	280.8
GT80158-P1010-S08	10	08	111.2	GT80158-P1210-S48	12	48	280.8
GT80158-P1210-S06	12	06	111.2	GT80158-P1810-S42	18	42	280.8
GT80158-P1410-S04	14	04	111.2	GT80158-P2410-S36	24	36	280.8
GT80158-P1610-S02	16	02	111.2	GT80158-S72	0	72	326.4
GT80158--S24	0	24	134	GT80158-P0610-S66	06	66	326.4
GT80158-P1610-S18	06	18	134	GT80158-P1210-S60	12	60	326.4
GT80158-P1210-S12	12	12	134	GT80158-P2410-S48	24	48	326.4
GT80158-P0810-S06	18	06	134	GT80158-P3610-S36	36	36	326.4
GT80158-P2410	24	0	134	GT80158-S84	0	84	375
GT80158-S30	0	30	161.8	GT80158-P1210-S72	12	72	375

GT80158-P0610-S24	06	24	161.8	GT80158F-P2410-S60	24	60	375
GT80158-P1210-S18	12	18	161.8	GT80158F-S96	0	96	420.6

Note: N channels 10A rings parallel can be used as 1 channel N*10A current. For example: 2 rings 10A parallel could be used as 1 wires 20A.
10A,5A (signal) can combine freely in any way.It can be customized based on standard slip ring,please contact customer service for more detmails.

Specifications

Electrical Data		
Parameter	Value	
	Power	Signal
Rated Voltage	0~690VAC/VDC	0~440VAC/VDC
Insulation Resistance	≥1000MΩ/1000VDC	≥1000MΩ/500VDC
Lead Wires	AWG16#Teflon	AWG22#Teflon
Lead Length	standard 300mm(adjustable)	
Insulation Strength	1000VAC@50Hz, 60s	
Electrical Noise	<0.03Ω	
Mechanical Data		
Parameter	Value	
Working Life	See Product Quality Level Table	
Rotating Speed	See Product Quality Level Table	
Working Temperature	-30°C~80°C	
Operating Humidity	0~85% RH	
Contact Material	Precious Metal	
Housing Material	Aluminium Alloy	
Protection Grade	IP51	

Lead Wires Color Code

Ring	1	2	3	4	5	6	7	8	9	10	11	12
Color	BLK	RED	YLW	GRN	BLU	WHT	BLK	RED	YLW	GRN	BLU	WHT

(6 wires for 1 group color, from 7-12, repeat the same color as 1...6, indicated with number code pipe)

Options for custom slip ring

Note: Below special demands can be customized. According, the delivery date will be extended 3 to 15 days; also the cost will be increased 30% to 50%. Most of our basic parts are standard and modular, which can save the cost and lead time.

- ① Cable exit way and cable length can be customized for both rotor and stator.
- ② Because of the structure limitation, length/height/OD can be customized on your request.
- ③ Support current or signal up to 200 rings.
- ④ Aviation plug, terminal and heat-shrink tube are optional.
- ⑤ Hybrid slip ring for Yaskawa/Panasonic/Siemens servo control signal, power line and encoder line.
- ⑥ Support mixed high speed data transmission (including Ethernet, USB, RS232, RS485, Profibus, CanBUS, CANOPEN, DeviceNET, CC-LINK, ProfiNET, EtherCAT, etc.)
- ⑦ Can combine temperature control signal with thermocouple signal.
- ⑧ Special environment can be customized, such as quakeproof, high temperature, etc.
- ⑨ Hybrid Pneumatic/hydraulic and electric slip ring can be mixed.
- ⑩ High temperature can up to 500 degrees.
- ⑪ High pressure can up to 110KV
- ⑫ Rotating speed can up to 10000RPM
- ⑬ Maximum current can up to 5000 amperes.
- ⑭ Military grade
- ⑮ Optional for underwater IP65, IP68.
- ⑯ Optional for stainless steel housing

Technical support: technical@moflon.com